

INFRASTRUCTURE



NORMA® Infrastructure Catalogue

Technical Building Equipment | Civil & Structural Engineering | Industry | Shipbuilding



Valid from

03/2023



NORMA

norma-connects.com

Connections made easy, built to last

NORMA values strong partnerships and long-lasting connections.

As a customer, you benefit from a huge selection of connection solutions and tailor-made services, making NORMA® the strongest link in your business, production, or maintenance chains. We stand for a connection that lasts.



A partner at your side

We recognize that our success is built on yours. Your NORMA contact person works where YOU are: no call center, no distance. They are responsive to your needs, speak your language, and share a common cultural understanding.



Long-lasting and proven products

Since 1949, NORMA® is a synonym for connection solutions that meet the highest quality standards and performance requirements at all times. NORMA's "fit and forget" commitment means worry-free installation without subsequent complaints or damage, driving satisfaction for you and your customers.



Universal product portfolio

Thanks to our wide range of products, we are your one-stop shop for every challenge in the field of connection and fastening technology. Our globally renowned NORMA® brand inspires confidence, making sales easier and distinguishing your business from the competition.

Professional solutions for every profession

Whether you are an engineer, a plumber or an architect, we can assure you that, as a professional user, you will love our extensive range of connectors and fasteners. Our pipe couplings, hose clamps, fastening elements and compression fittings are technologically advanced and will help you maintain operational integrity and safety even in critical applications. With our leading brand NORMA®, we offer you first-class quality, unmatched reliability and outstanding performance. This is the reason why we have been setting the standards for excellence in advanced joining technology for over seven decades.

What professional users love about NORMA:

- ✓ **Win time**
No time to bother with small components? Our NORMA® quality standard ensures accuracy of fit during assembly as well as simple and safe handling. We take care of your connecting components, so you can focus on the big system.
- ✓ **Save money**
You want to avoid high maintenance cost? Our products require no maintenance, they are made to last. But if your system does, our products allow you to execute it quickly and easily, as our products can be easily disassembled and reassembled.
- ✓ **Enjoy peace of mind**
You need a long-lasting system without leaks? NORMA's "Fit and Forget" commitment and the broad range of product and quality certifications mean worry-free installation without subsequent complaints or damage, driving satisfaction for you and your customers.



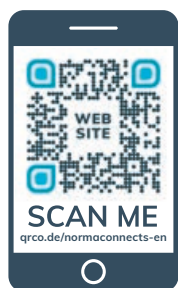

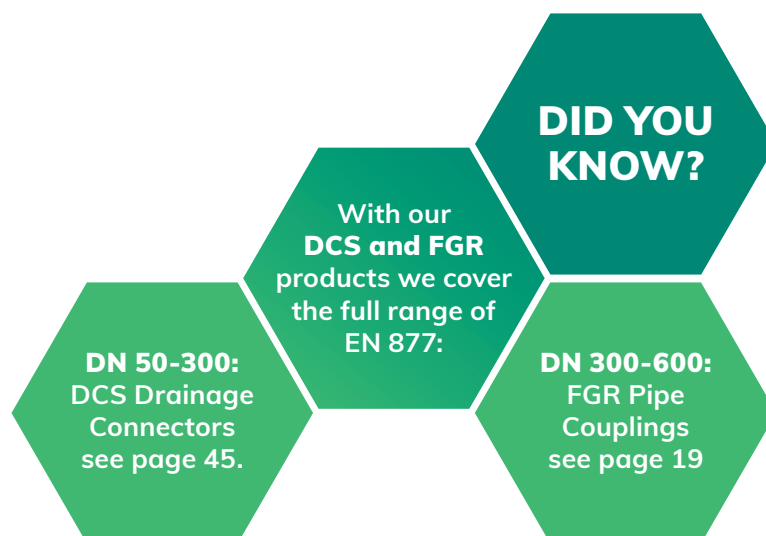

Don't let your connections be your weakest link!



FIND MORE INFORMATION:
NORMA-CONNECTS.COM



INDEX





Product Family	Product Category	Product Name	Page
 FGR FLEX	NORMACONNECT®	FGR	
		FLEX	19 – 23
		FLEX E	19 – 23
		FLEX 3	24 – 25
		GRIP	26 – 30
		GRIP E	26 – 30
		GRIP E-FP	31 – 32
		RFP	33
		PLAST GRIP	34 – 35
		PLAST GRIP E	34 – 35
		COMBI GRIP	36 – 37
		COMBI GRIP E	36 – 37
		SUPPORT SLEEVE	38 – 39
REP E	40 – 41		
 FGR GRIP E-FP	DCS	RAPID	45
		RAPID MSM	46
		UNIVERSAL CLAW	47
		RECORD CLAW	48
		COMBI CLAW	49
		CONFIX	50
		OVERVIEW PRODUCT RANGE	52 – 53
 FGR COMBI GRIP	Compression Fittings	TORRO®	56 – 58
		QUICK LOCK 9 MM	60 – 61
		QUICK LOCK 12 MM	62
		GBS	63 – 64
 DCS RAPID	NORMAFIX®	NORMETTA	66 – 69
		CABLE TIES	70 – 71
 DCS COMBI Restraint Collar	KITS, ASSORTMENTS AND TOOLS	NORMAFIX® NORMETTA® Mini repair kits	74
		NORMACLAMP® Quick Lock Band-on-roll	74
		NORMACLAMP® Quick Lock Band-on-roll dispenser	74
		NORMACLAMP® TORRO® Dispenser	75
		NORMACLAMP® TORRO® Assortment type 120 pcs	75
 TORRO	USER INFORMATION		77
 NORMETTA			

Materials explanation

- W1 All parts entirely made from galvanized steel
- W2 NORMACLAMP® TORRO®: Band and housing stainless steel AISI 430; Screw: galvanized mild steel
NORMACLAMP® GBS: Band and housing stainless steel AISI 430; Bolt: galvanized mild steel
NORMACONNECT® FGR/DCS: see pages 14 and 30
- W2B Band: stainless steel AISI 430, Screw and housing: galvanized steel
- W3 All parts entirely made from stainless steel AISI 430
- W4 All parts entirely made from stainless steel AISI 304 (or comparable)
- W5 All parts entirely made from stainless steel AISI 316 (or comparable)

Materials International standard designations						
	DIN	AISI/AS	BS	AFNOR NF	SS	SUS
W1	Entirely galvanized steel					
Band and housing						
W2	1.4016	430	430 S 17	Z8 C17	2320	430
Bolt	Galvanized steel					
W3	1.4016	430	430 S 17	Z8 C17	2320	430
W4	1.4301	304	304 S 15	Z6 CN 18-09	2332	304
W5	1.4401	316	316 S 31	Z3 CND 17-11-1	2347	316
Spring insert	1.4310	301	301 S 22	Z12 CN 18-09	2331	301

Bolts

- Sk**  Hexagonal-head bolt
- Sz**  Slotted hexagonal-head bolt
- Zv**  Cylinder-head bolt
- Isk**  Inside hexagonal screw

Pictogram explanation

NORMA® offers different tools, kits, assortments and displays to fit the needs of its customers. The drawings below will help you to know, at a quick glance, if the product is available in another packaging type and/or if it has a special tool.



This product is available in a kit, please refer to the Assortment chapter



This product is available in an assortment box, please refer to the Assortment chapter



This product is available in display, please refer to the Assortment chapter

NORMA® solutions for drainage and building



NORMA® FGR

- Applications:
- Cooling lines
 - Pressurized lines
 - Supply lines
 - Water
 - Gas
 - Hydraulic lines



NORMA® DCS Rapid

- Applications:
- Grey water
 - Roof drainage
 - Soil pipe lines
 - Black water



NORMA® DCS Combi Claw

- Applications:
- Roof drainage
 - Waste water lifting device
 - Lifting device



NORMA® TORRO®

- Applications:
- Pressurized lines

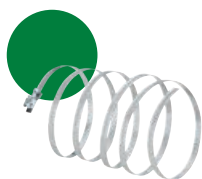

NORMA® Quick Lock

- Applications:
- Air conditioning lines
 - Exhaustion lines



NORMA® Cable Ties

- Applications:
- General fixing
 - Electrical lines

NORMA® solutions for sewage plants and industrial plants



NORMA® FGR

Applications:

- Sludge Treatment: composition lines, filtrate lines, sludge lines, water lines, compressor lines, biogas lines
- Biological Cleaning: compressor lines, ventilation lines, air lines
- Mechanical Cleaning: ventilation lines, floating lines, sludge lines, mixing water lines



NORMA® TORRO®

Applications:

- Hydraulic lines
- Pressurized lines



NORMA® Cable Ties

- Applications:
- General fixing

NORMA® solutions for shipbuilding



NORMA® FGR

- Applications:
- Black and grey water
 - Fresh water
 - Ballast lines
 - Bilge water
 - Springler systems
 - Discharge lines
 - Charge air lines
 - Lubrication lines



NORMA® TORRO®

- Applications:
- Hydraulic lines
 - Lubrication lines
 - Cooling lines
 - Pressure air lines



NORMA® FGR RFP

- Applications:
- Black and grey water
 - Fresh water
 - Ballast lines
 - Bilge water
 - Springler systems
 - Discharge lines
 - Charge air lines
 - Lubrication lines



NORMA® Cable Ties

- Applications:
- General fixing



NORMACONNECT® FGR – Pipe Couplings

The NORMACONNECT® FGR pipe coupling is a connection suitable to safely join thick- and thin-walled plastic and metal pipes and especially pipes made from stainless steel. It connects plain-ended supply pipes as well as exhaust pipes for solid, liquid or gaseous media in a reliable manner. The connecting elements help to reduce assembly times and costs significantly, because they eliminate the need for additional expenses such as welding, galvanizing or pipe alignment and treatment of pipe ends. Furthermore, NORMACONNECT® FGR is light, reusable, can be used in narrow spaces and resists high vibration loads due to its special geometry. NORMACONNECT® FGR couplings are used in mechanical engineering and construction, shipbuilding, civil engineering and in hydro technology.



Our solution for connecting – FGR

FGR pipe couplings are a compact, economical and reliable means for connecting plain-ended pipes. They are suitable for joining plastic and metal pipes and especially pipes made from stainless steel. They can be used in mechanical engineering and construction, shipbuilding, civil engineering and in hydro technology, water supply and water treatment.

Supply pipes as well as exhaust pipes for solid, liquid or gaseous media can be joined easily and safely in a very short period of time even in narrow spaces. Thanks to the wide range of various types and sizes they are suitable for use both in standard and specialized applications.

Product benefits

FGR pipe couplings are an economical alternative to conventional pipe joining techniques for both plastic and metal pipes. All plain-ended pipes can be joined easily by hand. The ready-to-fit coupling is pushed over the pipe ends and then aligned and rotated to any fitting position. Tightening the two bolts alternately with a torque wrench is all it takes to make a safe fitting.

Range of applications

FGR pipe coupling is a reliable connection for thick- and thin-walled pipes which conforms to the latest DIN Standard 86128. Feed and return lines for liquids, gases and solids (for mechanical engineering and construction, civil engineering, shipbuilding, pipeline construction, power stations, mining, filters, water technology, etc.) are joined quickly, easily and safely using FGR pipe couplings.

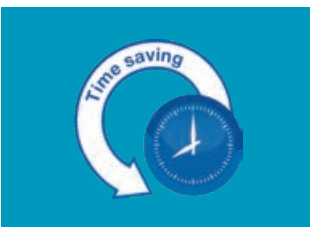
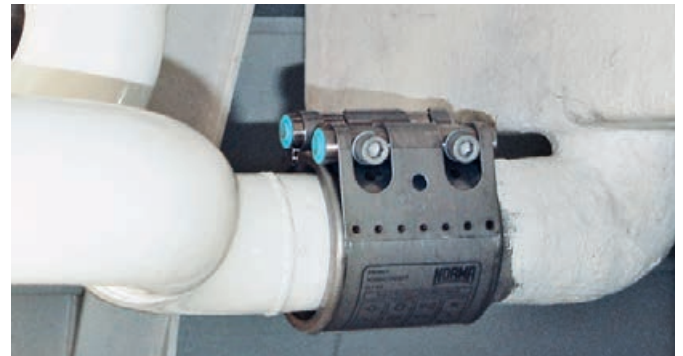

- No welding
- No necessity for prior pipe alignment or treatment of pipe ends
- Up to 80 % time saving



- Compensates for pipe gaps up to 65 mm
- Compensates for axial movements up to 7,5 mm
- Compensates for misalignment up to 3 mm



- 70 % less weight



- Compensates for angular deflection up to + or - 2° in total

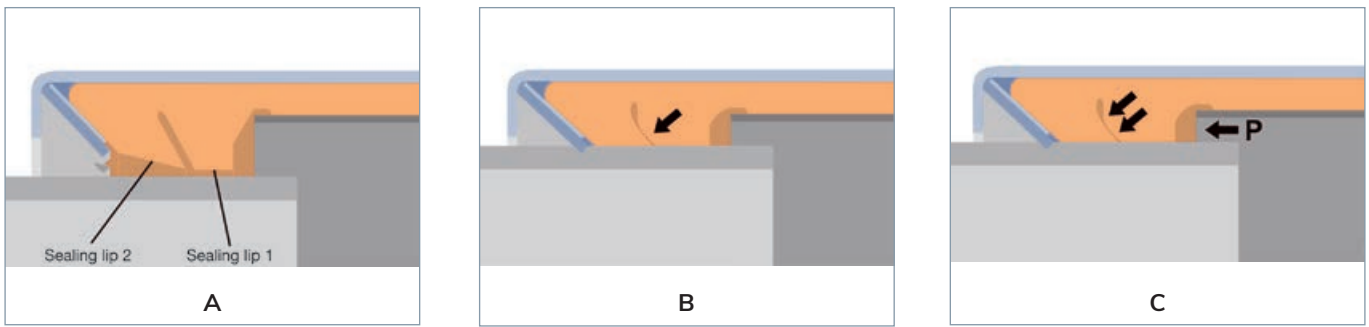

1. Double-lip sealing system

The patented double-lip sealing system of the FGR pipe couplings offers double safety. It provides maximum sealability at both low and high operating pressures (Fig. A).

When the bolts of the coupling are tightened, sealing lip 1 is pressed onto sealing lip 2, thus providing a highly reliable seal even under conditions of low pressure, vacuum or extreme loads acting on the joint (Fig. B).

The special sealing lip design means that when the internal pressure (P) increases, the sealing lips are pressed more firmly onto the pipe surface ensuring an even stronger seal (Fig. C).

2. Strip insert included as standard

All FGR pipe couplings are factory equipped with the strip insert as standard. The strip insert protects the sealing sleeve from increased mechanical and chemical loads. It also prevents the sealing sleeve from moisture expansion and allows larger gaps between the pipe ends to be connected.

Furthermore, it compensates for larger angular deflections and misalignment. With the strip insert the couplings can also be used for both vacuum and high pressure applications without any problems. The strip inserts are made from plastic material or stainless steel.

3. Heavy duty lock bars

For FGR pipe couplings we use lock bars with a larger diameter. Thus the rigidity of the coupling is increased and the engagement of the threaded end of the locking bolts is considerably improved.

4. Anchoring ring with conically stamped teeth







The anchoring ring with conically stamped teeth indents into the pipe surface and provides safe and strong axial restraint. Owing to the special design the coupling is able to withstand even high vibration loads.

5. Protection ring



The protection ring protects the sealing sleeve from UV rays, fire, etc., and increases the flexural strength of the coupling.





Approvals

SHIPBUILDING		FLEX / FLEX E / RFP	GRIP / GRIP E / Grip E-FP / RFP	CombiGrip / CombiGrip E	PlastGrip / PlastGrip E	Rep E
ABS		•	•	•	•	
Bureau Veritas		•	•	•	•	
DNV		•	•	•	•	
LR		• ¹	• ¹	•	•	
RINA		•	•			
MRS		•	•	•	•	
PRS		• ¹	• ¹			

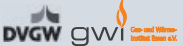

Water supply & treatment

Elastomer guideline KTW/TZW W270		•	•	•	•	•
DVGW					• ²	
GOST		•	•	•	•	•
NSF		•	•	•	•	

GAS

DVGW / gwi			•			
BAM			•		•	

Special approvals

DIBT / TÜV south. Germany			•			
BAAINBW			• ³			
FDA		•	•	•	•	

¹ No approvals for RFP

² From 40.0 mm up to 160 mm

³ Approval for German Navy / NATO vessels

Pressure rating for axial non restraint pipe couplings type Flex

Pipes to be joined	Size (mm)	Flex	Flex E	Flex 3	REP E from 35 mm
Metal + Metal	26.9 to 168.3	70 to 32 bar	70 to 32 bar	-	60 to 32 bar
	180.0 to 1219.2	50 to 7 bar	30 to 4 bar	-	30 to 4 bar
	326.0 to 2032.0	-	-	16.5 to 1.5 bar	-
Plastic + Plastic	26.9 to 168.3	16 bar	16 bar	-	16 bar
	180.0 to 1219.2	16 to 4 bar	16 to 4 bar	-	16 to 4 bar
Metal + Plastic	26.9 to 168.3	16 bar	16 bar	-	-
	180.0 to 1219.2	16 to 7 bar	16 to 7 bar	-	-

Larger diameters available on request

Pressure rating for axial restraint pipe couplings type Grip

Pipes to be joined	Size (mm)	Grip	Grip E	Combi-Grip E	Combi-Grip	Plast-Grip E	Plast-Grip	Grip E-FP
Metal + Metal	26.9 to 168.3	70 to 32 bar	70 to 32 bar	-	-	-	-	60 to 32 bar
	180.0 to 419.0	-	20 to 2 bar	-	-	-	-	20 to 65 bar
	180.0 to 812.8	32 to 1 bar	-	-	-	-	-	-
Plastic + Plastic	40.0 to 168.3	-	-	-	-	16 bar	-	-
	200.0 to 406.4	-	-	-	-	-	16 to 6 bar	-
Metal + Plastic	38/40 to 160/168.3	16 bar	16 bar	16 bar	-	-	-	-
	200.0/204.0 to 406.0/406.4	-	-	-	16 to 6 bar	-	-	-

Larger diameters available on request

Sealing sleeves

Material of seal	EPDM	NBR	FKM
Temperature range	-30 °C up to +125 °C OD 26.9 up to 168.3 mm -20 °C up to +80 °C OD > 180 mm	-20 °C up to +80 °C	-10 °C to +150 °C*
Media	Drinking water Alcohols Compressed air Solids	Water Oils Gases (combustible) Fuels Hydrocarbons	Steam Several gases Hot water Ozone Oxygen Several acids** Several alkalis** Hydrocarbons

* Higher temperatures possible in some cases

** Case by case approval required. Please check with your sales representative

FGR Materials

Components and materials in accordance with AISI/BS. FGR pipe couplings are available in the materials W2, W4 and W5.

W2				
No.	Component	Flex/Flex E	Grip/Grip E	Plast Grip/ Plast Grip E
1	Housing with bridge	304/304 S31	304/304 S31	304/304 S31
2	Sealing sleeve	EPDM/NBR	EPDM/NBR	EPDM/NBR
3	Strip insert ¹⁾	316Ti/320 S31/PA-GR	316Ti/320 S31/PA-GR	316Ti/320 S31/PA-GR
4 A	Anchoring ring for metal pipes ²⁾	–	301/301 S21	–
4 A	Anchoring ring for plastic pipes ²⁾	–	–	PA-GF-NS ³⁾
4 B	Protection ring	316Ti/320 S31	–	–
5 + 6	Solid locking trunnions	AISI 1213	AISI 1213	AISI 1213
5 + 6	Hollow locking trunnions	AISI 1518	AISI 1518	AISI 1518
7	Locking bolts	10.9	10.9	10.9
8	Washer	A4-80/316	A4-80/316	A4-80/316

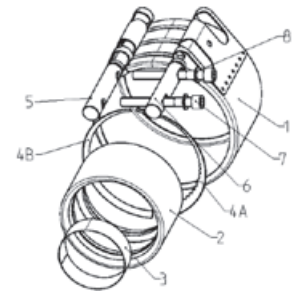

W4				
No.	Component	Flex/Flex E	Grip/Grip E	Plast Grip/ Plast Grip E
1	Housing with bridge	304/304 S31	304/304 S31	304/304 S31
2	Sealing sleeve	EPDM/NBR	EPDM/NBR	EPDM/NBR
3	Strip insert ¹⁾	316Ti/320 S31/PA-GR	316Ti/320 S31/PA-GR	316Ti/320 S31/PA-GR
4 A	Anchoring ring for metal pipes ²⁾	–	301/301 S21	–
4 A	Anchoring ring for plastic pipes ²⁾	–	–	PA-GF-NS ³⁾
4 B	Protection ring	316Ti/320 S31	316Ti/320 S31	–
5 + 6	Solid locking trunnions	316L	316L	316L
5 + 6	Hollow locking trunnions	316Ti/320 S31	316Ti/320 S31	316Ti/320 S31
7	Locking bolts	A4-80/316	A4-80/316	A4-80
8	Washer	A4-80/316	A4-80/316	A4-80

¹⁾ PA-GF plastic strip inserts are only for pipe couplings used in shipbuilding applications.

²⁾ COMBI GRIP couplings are equipped with two different anchoring rings (1 x for the metal end, 1 x for the plastic end).

³⁾ PA-GF: PA reinforced with fiber glass; NS: new silver.

W5						
No.	Component	Flex/Flex E	Grip/Grip E	Combi Grip/ Combi Grip E	Plast Grip/ Plast Grip E	Rep E
1	Housing	316Ti/320 S31	316Ti/320 S31	316Ti/320 S31	316Ti/320 S31	316Ti/320 S31
2	Sealing sleeve	EPDM/NBR/FKM	EPDM/NBR/FKM	EPDM/NBR	EPDM/NBR	EPDM/NBR
3	Strip insert ¹⁾	316Ti/320 S31/PA-GR	316Ti/320 S31/PA-GR	316Ti/320 S31/PA-GR	316Ti/320 S31/PA-GR	316Ti/320 S31/PA-GR
4 A	Anchoring ring for metal pipes ²⁾	–	301/301 S21	301/301 S21 301/301 S21	–	–
4 A	Anchoring ring for plastic pipes ²⁾	–	–	PA-GF-NS ³⁾	PA-GF-NS ³⁾	–
4 B	Protection ring	316Ti/320 S31	–	–	–	–
5 + 6	Solid locking trunnions	316L	316L	316L	316L	316L
5 + 6	Hollow locking trunnions	316Ti/320 S31	316Ti/320 S31	316Ti/320 S31	316Ti/320 S31	316Ti/320 S31
7	Locking bolts	A4-80/316	A4-80/316	A4-80/316	A4-80/316	A4-80/316
8	Washer	A4-80/316	A4-80/316	A4-80/316	A4-80/316	A4-80/316

¹⁾ PA-GF plastic strip inserts are only for pipe couplings used in shipbuilding applications.

²⁾ COMBI GRIP couplings are equipped with two different anchoring rings (1 x for the metal end, 1 x for the plastic end).

³⁾ PA-GF: PA reinforced with fiber glass; NS: nickel and silver.

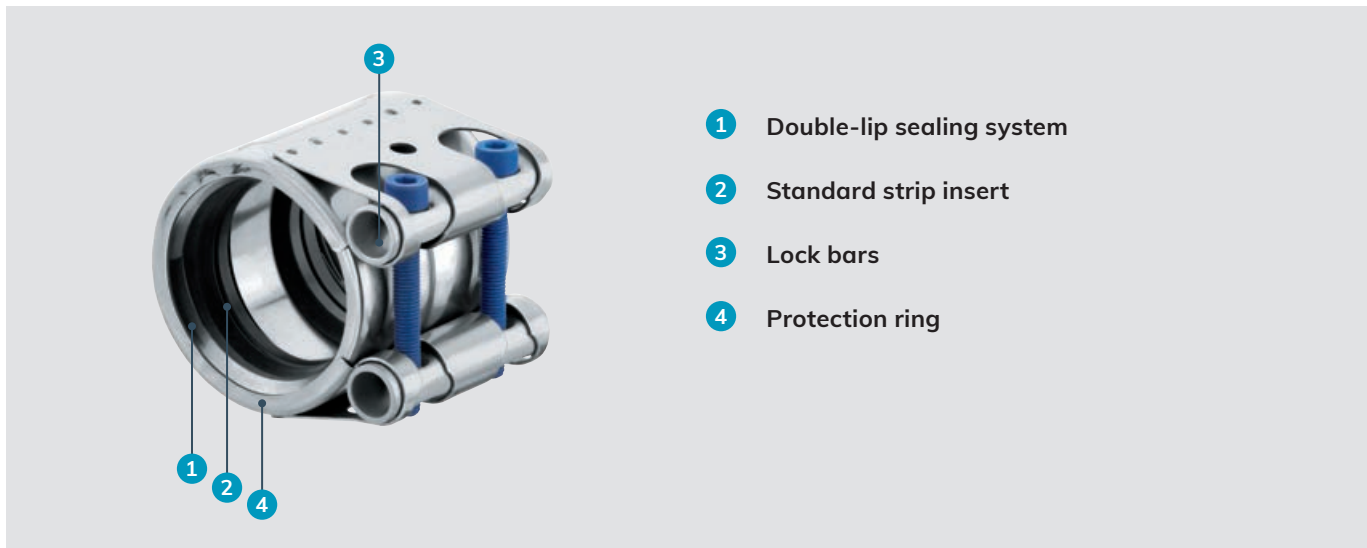

The protective pipe coupling

NORMACONNECT® FLEX /FLEX E are axial non-restraint couplings. They are used for all kind of metal pipes, as well as pipes made of concrete or plastic. Sealing reliability is ensured even when NORMACONNECT® FLEX /FLEX E pipe couplings are mounted on pipes with or without a gap and also on compensated pipes.



Advantages at a glance

- ✓ Compensates for thermal elongation of the pipes
- ✓ Joining all kind of pipe materials is possible, e.g., for steel, plastic, cast iron, etc.

Information

- Sizes: 26.9 mm – 1219.1 mm
- Working pressure: 70.0 – 4.0 bar
- Material: AISI 304, AISI 316 Ti
- EPDM:
 Sizes from 26.9 mm up to 168.3 mm: -30 °C up to +125 °C
 Sizes > 180.0 mm: -20 °C up to +80 °C
- NBR: from -20 °C up to +80 °C
- FKM: -10 °C to +150 °C
 (Higher temperatures possible in some cases.)

Materials

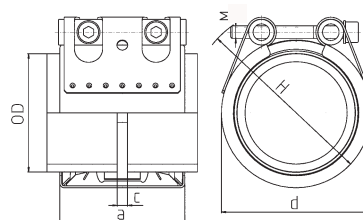

W1	W2	W3	W4	W5
	x		x	x

Technical data & Ordering information



Technical data & Ordering information

NORMACONNECT®

NORMACONNECT® FGR FLEX E											
Ø (O.D.)	Designation	Clamping ranges	PN ¹	WP ²	C max	Dimensions (approx.)			Weight (approx.)	Hex socket locking bolts	
			(MAWP ¹ from diameter 180)				a (mm)	d (mm)		H (mm)	Thread
											
			[bar]	[bar]	(mm)	(mm)	(mm)	(mm)	(kg/pc.)		
26.9	Flex E 26.9	26.4-27.5	16	70	3	67	50	70	0.31	M 8 SW 6	5
28.0	Flex E 28.0	27.5-28.5	16	70	3	67	50	70	0.31	M 8 SW 6	5
30.0	Flex E 30.0	29.5-30.6	16	70	3	67	50	70	0.31	M 8 SW 6	5
33.7	Flex E 33.7	33.0-34.3	16	60	3	67	55	75	0.32	M 8 SW 6	5
35.0	Flex E 35.0	34.5-35.6	16	60	8	63	55	75	0.43	M 8 SW 6	5
38.0	Flex E 38.0	37.5-38.6	16	60	8	63	60	80	0.43	M 8 SW 6	5
42.4	Flex E 42.4	41.7-43.0	16	50	8	63	65	85	0.44	M 8 SW 6	5
44.5	Flex E 44.5	44.0-45.1	16	50	8	63	65	85	0.45	M 8 SW 6	5
48.3	Flex E 48.3	47.6-50.5	16	50	8	63	70	90	0.46	M 8 SW 6	5
54.0	Flex E 54.0	53.3-54.6	16	50	17	78	75	95	0.60	M 8 SW 6	10
57.0	Flex E 57.0	56.3-57.7	16	50	17	78	80	100	0.61	M 8 SW 6	10
60.3	Flex E 60.3	59.5-61.0	16	40	17	78	85	105	0.62	M 8 SW 6	10
63.0	FLEX E 63.0	62.2-63.9	16	40	17	78	85	105	0.62	M 8 SW 6	10
70.0	Flex E 70.0	69.0-71.0	16	40	25	98	90	110	1.16	M 8 SW 6	10
73.0	Flex E 73.0	72.1-73.8	16	40	25	98	95	115	1.18	M 8 SW 6	10
76.1	Flex E 76.1	75.2-77.0	16	35	25	98	100	120	1.18	M 8 SW 6	10
80.0	Flex E 80.0	79.0-80.8	16	35	25	98	100	120	1.21	M 8 SW 6	10
84.0	Flex E 84.0	83.0-85.0	16	35	25	98	105	125	1.24	M 8 SW 6	10
88.9	Flex E 88.9	87.0-89.9	16	35	25	98	110	130	1.26	M 8 SW 6	10
101.6	Flex E 101.6	100.4-102.8	16	35	25	98	125	145	1.39	M 8 SW 6	10
104.0	Flex E 104.0	102.8-106.1	16	35	25	98	125	145	1.40	M 8 SW 6	10
108.0	Flex E 108.0	106.8-109.2	16	35	25	98	130	150	1.42	M 8 SW 6	10
110.0	Flex E 110.0	108.8-111.4	16	35	25	98	130	150	1.47	M 8 SW 6	10
114.3	Flex E 114.3	113.0-115.5	16	35	25	98	135	155	1.47	M 8 SW 6	15
129.0	Flex E 129.0	127.6-131.1	16	32	35	113	155	185	2.10	M 10 SW 8	20
133.0	Flex E 133.0	131.5-134.4	16	32	35	113	160	190	2.13	M 10 SW 8	20
139.7	Flex E 139.7	138.1-141.6	16	32	35	113	165	195	2.19	M 10 SW 8	25
141.3	Flex E 141.3	139.6-142.8	16	32	35	113	170	200	2.19	M 10 SW 8	25
154.0	Flex E 154.0	152.3-156.1	16	32	35	113	180	210	2.31	M 10 SW 8	30
159.0	Flex E 159.0	157.3-160.7	16	32	35	113	185	215	2.38	M 10 SW 8	30
168.3	Flex E 168.3	166.5-170.1	16	32	35	113	195	225	2.43	M 10 SW 8	30

PN¹ (Nominal Pressure) is the max. admissible working pressure in shipbuilding, based on a safety factor of ≥ 4.
 MAWP¹ (Maximum Allowable Working Pressure) is the max. admissible working pressure in shipbuilding, based on a safety factor of ≥ 4.
 WP² is the max. working pressure in industrial applications, with a safety factor as per NORMA specification.

Technical data & Ordering information

NORMACONNECT® FGR FLEX E								
Ø (O.D.)	Designation	W2 Product No.		W4 Product No.		W5 Product No.		
		EPDM	NBR	EPDM	NBR	EPDM	NBR	FKM
26.9	Flex E 26.9	0582 9100 026	0582 8400 026	0582 9200 026	0582 8500 026	0582 9300 026	0582 8600 026	
28.0	Flex E 28.0	0582 9100 028	0582 8400 028	0582 9200 028	0582 8500 028	0582 9300 028	0582 8600 028	
30.0	Flex E 30.0	0582 9100 030	0582 8400 030	0582 9200 030	0582 8500 030	0582 9300 030	0582 8600 030	
33.7	Flex E 33.7	0582 9100 033	0582 8400 033	0582 9200 033	0582 8500 033	0582 9300 033	0582 8600 033	0582 9900 033
35.0	Flex E 35.0	0582 9100 035	0582 8400 035	0582 9200 035	0582 8500 035	0582 9300 035	0582 8600 035	
38.0	Flex E 38.0	0582 9100 038	0582 8400 038	0582 9200 038	0582 8500 038	0582 9300 038	0582 8600 038	0582 9900 038
42.4	Flex E 42.4	0582 9100 042	0582 8400 042	0582 9200 042	0582 8500 042	0582 9300 042	0582 8600 042	0582 9900 042
44.5	Flex E 44.5	0582 9100 044	0582 8400 044	0582 9200 044	0582 8500 044	0582 9300 044	0582 8600 044	
48.3	Flex E 48.3	0582 9100 048	0582 8400 048	0582 9200 048	0582 8500 048	0582 9300 048	0582 8600 048	0582 9900 048
54.0	Flex E 54.0	0582 9100 054	0582 8400 054	0582 9200 054	0582 8500 054	0582 9300 054	0582 8600 054	
57.0	Flex E 57.0	0582 9100 057	0582 8400 057	0582 9200 057	0582 8500 057	0582 9300 057	0582 8600 057	0582 9900 057
60.3	Flex E 60.3	0582 9100 060	0582 8400 060	0582 9200 060	0582 8500 060	0582 9300 060	0582 8600 060	0582 9900 060
63.0	FLEX E 63.0	0582 9100 063	0582 8400 063	0582 9200 063	0582 8500 063	0582 9300 063	0582 8600 063	0582 9900 063
70.0	Flex E 70.0	0582 9100 070	0582 8400 070	0582 9200 070	0582 8500 070	0582 9300 070	0582 8600 070	
73.0	Flex E 73.0	0582 9100 073	0582 8400 073	0582 9200 073	0582 8500 073	0582 9300 073	0582 8600 073	
76.1	Flex E 76.1	0582 9100 076	0582 8400 076	0582 9200 076	0582 8500 076	0582 9300 076	0582 8600 076	0582 9900 076
80.0	Flex E 80.0	0582 9100 080	0582 8400 080	0582 9200 080	0582 8500 080	0582 9300 080	0582 8600 080	
84.0	Flex E 84.0	0582 9100 084	0582 8400 084	0582 9200 084	0582 8500 084	0582 9300 084	0582 8600 084	
88.9	Flex E 88.9	0582 9100 088	0582 8400 088	0582 9200 088	0582 8500 088	0582 9300 088	0582 8600 088	0582 9900 088
101.6	Flex E 101.6	0582 9100 101	0582 8400 101	0582 9200 101	0582 8500 101	0582 9300 101	0582 8600 101	
104.0	Flex E 104.0	0582 9100 104	0582 8400 104	0582 9200 104	0582 8500 104	0582 9300 104	0582 8600 104	
108.0	Flex E 108.0	0582 9100 108	0582 8400 108	0582 9200 108	0582 8500 108	0582 9300 108	0582 8600 108	
110.0	Flex E 110.0	0582 9100 110	0582 8400 110	0582 9200 110	0582 8500 110	0582 9300 110	0582 8600 110	
114.3	Flex E 114.3	0582 9100 114	0582 8400 114	0582 9200 114	0582 8500 114	0582 9300 114	0582 8600 114	0582 9900 114
129.0	Flex E 129.0	0582 9100 129	0582 8400 129	0582 9200 129	0582 8500 129	0582 9300 129	0582 8600 129	0582 9900 129
133.0	Flex E 133.0	0582 9100 133	0582 8400 133	0582 9200 133	0582 8500 133	0582 9300 133	0582 8600 133	
139.7	Flex E 139.7	0582 9100 139	0582 8400 139	0582 9200 139	0582 8500 139	0582 9300 139	0582 8600 139	0582 9900 139
141.3	Flex E 141.3	0582 9100 141	0582 8400 141	0582 9200 141	0582 8500 141	0582 9300 141	0582 8600 141	
154.0	Flex E 154.0	0582 9100 154	0582 8400 154	0582 9200 154	0582 8500 154	0582 9300 154	0582 8600 154	
159.0	Flex E 159.0	0582 9100 159	0582 8400 159	0582 9200 159	0582 8500 159	0582 9300 159	0582 8600 159	
168.3	Flex E 168.3	0582 9100 168	0582 8400 168	0582 9200 168	0582 8500 168	0582 9300 168	0582 8600 168	0582 9900 168



NORMACONNECT® FLEX is an axial non-restraint coupling. It is used for connecting metal pipes, stainless pipes, as well as concrete and plastic pipes. This is a full trunnions version.

Material
W2, W4, W5

NORMACONNECT® FGR FLEX											
Ø (O.D.)	Designation	Clamping ranges	PN ¹	WP ²	C max	Dimensions (approx.)			Weight (approx.)	Hex socket locking bolts	
			(MAWP ¹ from Ø 180)	[bar]		[bar]	a (mm)	d (mm)		H (mm)	Thread
180.0	Flex 180.0	178.0 - 182.0	16.0	50.0	35	141	210	240	5.4	M 12 SW 10	35
193.7	Flex 193.7	192.0 - 196.0	16.0	46.0	35	141	225	255	5.6	M 12 SW 10	35
206.0	Flex 206.0	202.0 - 208.0	16.0	43.0	35	141	240	270	5.8	M 12 SW 10	35
219.0	Flex 219.0	216.0 - 221.0	16.0	40.5	35	141	250	280	6.0	M 12 SW 10	35
225.0	Flex 225.0	222.0 - 227.0	16.0	40.0	35	141	255	285	6.1	M 12 SW 10	35
229.9	Flex 229.9	228.0 - 232.0	16.0	39.0	35	141	260	290	6.2	M 12 SW 10	35
244.5	Flex 244.5	242.0 - 247.0	16.0	37.0	35	141	275	305	6.4	M 12 SW 10	35
254.0	Flex 254.0	250.0 - 256.0	16.0	35.5	35	141	285	315	6.5	M 12 SW 10	35
267.0	Flex 267.0	264.0 - 269.0	16.0	33.5	35	141	300	330	6.7	M 12 SW 10	35
273.0	Flex 273.0	270.0 - 275.0	16.0	33.0	35	141	305	335	6.8	M 12 SW 10	35
306.0	Flex 306.0	302.0 - 308.0	15.0	29.0	35	141	340	370	7.4	M 12 SW 10	35
323.9	Flex 323.9	320.0 - 327.0	15.0	28.0	35	141	355	385	7.6	M 12 SW 10	35
326.0	Flex 326.0	322.0 - 329.0	13.0	27.5	35	141	360	390	7.7	M 12 SW 10	35
355.6	Flex 355.6	352.0 - 359.0	13.0	25.0	35	141	390	420	8.1	M 12 SW 10	35
406.4	Flex 406.4	402.0 - 410.0	10.0	22.0	35	141	440	470	8.9	M 12 SW 10	35
429.0	Flex 429.0	426.0 - 431.0	7.5	21.0	35	141	460	490	9.3	M 12 SW 10	40
442.0	Flex 442.0	439.0 - 444.0	7.5	20.0	35	141	475	505	9.5	M 12 SW 10	40
457.2	Flex 457.2	454.0 - 459.0	7.5	19.5	35	141	490	520	9.7	M 12 SW 10	40
508.0	Flex 508.0	505.0 - 510.0	7.5	17.0	35	141	540	570	10.5	M 12 SW 10	40
531.0	Flex 531.0	528.0 - 534.0	7.5	16.0	35	141	565	595	10.9	M 12 SW 10	50
558.8	Flex 558.8	556.0 - 562.0	7.5	15.5	35	141	590	620	11.3	M 12 SW 10	50
609.6	Flex 609.6	606.0 - 613.0	6.0	14.0	35	141	640	670	12.1	M 12 SW 10	50
634.0	Flex 634.0	631.0 - 637.0	5.0	13.5	35	141	665	695	12.5	M 12 SW 10	50
711.2	Flex 711.2	707.0 - 715.0	5.0	12.0	35	141	745	775	13.7	M 12 SW 10	50
762.0	Flex 762.0	758.0 - 766.0	4.5	11.0	35	141	795	885	14.5	M 12 SW 10	50
812.8	Flex 812.8	808.0 - 817.0	4.5	10.5	35	141	845	935	17.2	M 12 SW 10	50
914.4	Flex 914.4	909.0 - 919.0	3.3	9.5	35	141	945	1035	18.8	M 12 SW 10	60
1016.0	Flex 1016.0	1013.0 - 1019.0	3.3	8.0	35	141	1050	1140	20.4	M 12 SW 10	60
1117.5	Flex 1117.5	1114.0 - 1120.0	3.3	7.5	35	141	1150	1240	22.0	M 12 SW 10	60
1219.2	Flex 1219.2	1216.0 - 1222.0	3.3	7.0	35	141	1250	1340	23.6	M 12 SW 10	60

PN¹ (Nominal Pressure) is the max. admissible working pressure in shipbuilding, based on a safety factor of ≥ 4.
MAWP¹ (Maximum Allowable Working Pressure) is the max. admissible working pressure in shipbuilding, based on a safety factor of ≥ 4.
WP² is the max. working pressure in industrial applications, with a safety factor as per NORMA specification.

Technical data & Ordering information

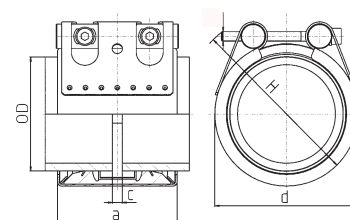

NORMACONNECT®

NORMACONNECT® FGR FLEX							
Ø (O.D.)	Designation	W2 Product No.		W4 Product No.		W5 Product No.	
		EPDM	NBR	EPDM	NBR	EPDM	NBR
180.0	Flex 180.0	0575 8140 180	0575 8440 180	0575 8240 180	0575 8540 180	0575 8340 180	0575 8640 180
193.7	Flex 193.7	0575 8140 193	0575 8440 193	0575 8240 193	0575 8540 193	0575 8340 193	0575 8640 193
206.0	Flex 206.0	0575 8140 206	0575 8440 206	0575 8240 206	0575 8540 206	0575 8340 206	0575 8640 206
219.0	Flex 219.0	0575 8140 219	0575 8440 219	0575 8240 219	0575 8540 219	0575 8340 219	0575 8640 219
225.0	Flex 225.0	0575 8140 225	0575 8440 225	0575 8240 225	0575 8540 225	0575 8340 225	0575 8640 225
229.9	Flex 229.9	0575 8140 229	0575 8440 229	0575 8240 229	0575 8540 229	0575 8340 229	0575 8640 229
244.5	Flex 244.5	0575 8140 244	0575 8440 244	0575 8240 244	0575 8540 244	0575 8340 244	0575 8640 244
254.0	Flex 254.0	0575 8140 254	0575 8440 254	0575 8240 254	0575 8540 254	0575 8340 254	0575 8640 254
267.0	Flex 267.0	0575 8140 267	0575 8440 267	0575 8240 267	0575 8540 267	0575 8340 267	0575 8640 267
273.0	Flex 273.0	0575 8140 273	0575 8440 273	0575 8240 273	0575 8540 273	0575 8340 273	0575 8640 273
306.0	Flex 306.0	0575 8140 306	0575 8440 306	0575 8240 306	0575 8540 306	0575 8340 306	0575 8640 306
323.9	Flex 323.9	0575 8140 323	0575 8440 323	0575 8240 323	0575 8540 323	0575 8340 323	0575 8640 323
326.0	Flex 326.0	0575 8140 326	0575 8440 326	0575 8240 326	0575 8540 326	0575 8340 326	0575 8640 326
355.6	Flex 355.6	0575 8140 355	0575 8440 355	0575 8240 355	0575 8540 355	0575 8340 355	0575 8640 355
406.4	Flex 406.4	0575 8140 406	0575 8440 406	0575 8240 406	0575 8540 406	0575 8340 406	0575 8640 406
429.0	Flex 429.0	0575 8140 429	0575 8440 429	0575 8240 429	0575 8540 429	0575 8340 429	0575 8640 429
442.0	Flex 442.0	0575 8140 442	0575 8440 442	0575 8240 442	0575 8540 442	0575 8340 442	0575 8640 442
457.2	Flex 457.2	0575 8140 457	0575 8440 457	0575 8240 457	0575 8540 457	0575 8340 457	0575 8640 457
508.0	Flex 508.0	0575 8140 508	0575 8440 508	0575 8240 508	0575 8540 508	0575 8340 508	0575 8640 508
531.0	Flex 531.0	0575 8140 531	0575 8440 531	0575 8240 531	0575 8540 531	0575 8340 531	0575 8640 531
558.8	Flex 558.8	0575 8140 558	0575 8440 558	0575 8240 558	0575 8540 558	0575 8340 558	0575 8640 558
609.6	Flex 609.6	0575 8140 609	0575 8440 609	0575 8240 609	0575 8540 609	0575 8340 609	0575 8640 609
634.0	Flex 634.0	0575 8140 634	0575 8440 634	0575 8240 634	0575 8540 634	0575 8340 634	0575 8640 634
711.2	Flex 711.2	0575 8140 711	0575 8440 711	0575 8240 711	0575 8540 711	0575 8340 711	0575 8640 711
762.0	Flex 762.0	0575 8140 762	0575 8440 762	0575 8240 762	0575 8540 762	0575 8340 762	0575 8640 762
812.8	Flex 812.8	0575 8140 812	0575 8440 812	0575 8240 812	0575 8540 812	0575 8340 812	0575 8640 812
914.4	Flex 914.4	0575 8140 914	0575 8440 914	0575 8240 914	0575 8540 914	0575 8340 914	0575 8640 914
1016.0	Flex 1016.0	0575 8141 016	0575 8441 016	0575 8241 016	0575 8541 016	0575 8341 016	0575 8641 016
1117.5	Flex 1117.5	0575 8141 117	0575 8441 117	0575 8241 117	0575 8541 117	0575 8341 117	0575 8641 117
1219.2	Flex 1219.2	0575 8141 219	0575 8441 219	0575 8241 219	0575 8541 219	0575 8341 219	0575 8641 219



- 1 Double-lip sealing system
- 2 Standard strip insert
- 3 Lock bars

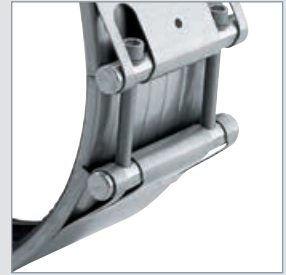

NORMACONNECT® FLEX 3 pipe coupling with extra wide band width of 211 mm

The pipe coupling with extra wide band

NORMACONNECT® FLEX 3 featuring an extra wide band is an axial non-restraint coupling used to connect metal and/or plastic pipes quickly and safely.



Advantages at a glance

- ✓ Easy and quick to assemble
- ✓ Pipe end distance up to 65 mm possible
- ✓ Compensation of misalignment, angular deflection up to 4° possible

Information

- Sizes: from 812.8 mm to 2032.0 mm
- Working pressure: 6.5 bar – 1.5 bar
- Solid trunnions
- 2 closure units
- Material: AISI 316 Ti
- EPDM: from -20 °C up to +80 °C
- NBR: from -20 °C up to +80 °C

Materials

W1	W2	W3	W4	W5
				x

Technical data & Ordering information

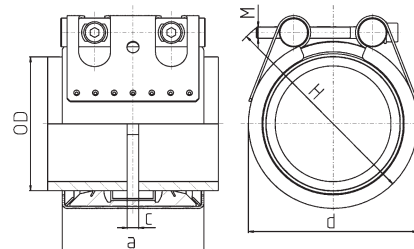

Technical data & Ordering information

NORMACONNECT® FGR FLEX 3												
Ø (O.D.)	Designation	Clamping ranges	WP ¹  [bar]	C max (mm)	Dimensions (approx.)			Weight (approx.) (kg/pc.)	Hex socket locking bolts		W5 Product No.	
					Oadmin - Odmx (mm)	a (mm)	d (mm)		H (mm)	Thread	Tightening torque (Nm)	EPDM
812.8	Flex 3 812.8	808.0 - 817.0	6.5	65	211	850	890	21.4	M 16 SW 14	45	0571 8330 812	0571 8630 812
914.4	Flex 3 914.4	909.0 - 919.0	6.0	65	211	950	990	23.4	M 16 SW 14	45	0571 8330 914	0571 8630 914
1016.0	Flex 3 1016.0	1013.0 - 1019.0	5.0	65	211	1055	1095	25.4	M 16 SW 14	50	0571 8331 016	0571 8631 016
1117.5	Flex 3 1117.5	1114.0 - 1120.0	4.5	65	211	1155	1195	27.4	M 16 SW 14	50	0571 8331 117	0571 8631 117
1219.2	Flex 3 1219.2	1216.0 - 1222.0	4.0	65	211	1255	1295	29.4	M 16 SW 14	55	0571 8331 219	0571 8631 219
1320.8	Flex 3 1320.8	1314.0 - 1328.0	3.0	65	211	1360	1400	31.4	M 16 SW 14	55	0571 8331 320	0571 8631 320
1422.4	Flex 3 1422.4	1415.0 - 1430.0	3.0	65	211	1460	1500	33.4	M 16 SW 14	60	0571 8331 422	0571 8631 422
1524.0	Flex 3 1524.0	1516.0 - 1532.0	2.5	65	211	1560	1600	35.4	M 16 SW 14	60	0571 8331 524	0571 8631 524
1625.6	Flex 3 1625.6	1617.0 - 1634.0	2.5	65	211	1665	1705	37.4	M 16 SW 14	70	0571 8331 625	0571 8631 625
1727.2	Flex 3 1727.2	1718.0 - 1736.0	2.0	65	211	1765	1805	39.4	M 16 SW 14	70	0571 8331 727	0571 8631 727
1828.8	Flex 3 1828.8	1819.0 - 1838.0	2.0	65	211	1865	1905	41.4	M 16 SW 14	80	0571 8331 828	0571 8631 828
1930.4	Flex 3 1930.4	1320.0 - 1940.0	2.0	65	211	1970	2010	43.4	M 16 SW 14	80	0571 8331 930	0571 8631 930
2032.0	Flex 3 2032.0	2021.0 - 2042.0	1.5	65	211	2070	2110	45.4	M 16 SW 14	80	0571 8332 032	0571 8632 032

WP¹ is the max. working pressure in industrial applications, with a safety factor as per NORMA specification.

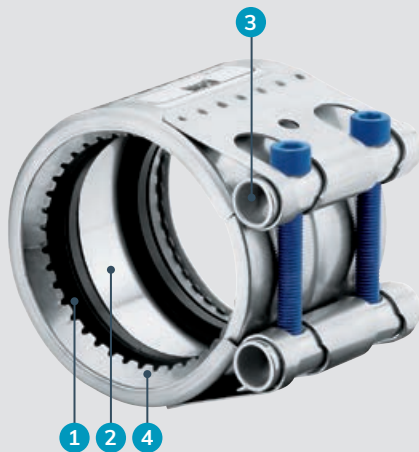

- 1 Double-lip sealing system
- 2 Standard strip insert
- 3 Lock bars
- 4 Anchoring ring with conically stamped teeth

The strong pipe coupling

NORMACONNECT® GRIP/GRIP E axial restraint pipe couplings are used to connect metal pipes. The anchoring ring with conically stamped teeth indents into the pipe surface (steel, stainless steel or cast iron) and provides safe and strong axial restraint. Owing to the special design, the coupling can withstand even high vibration loads.

Advantages at a glance

- ✓ Progressive locking effect ensures a trouble- and maintenance-free connection
- ✓ Reusable
- ✓ Shock resistant
- ✓ Space saving connector
- ✓ Withstand high vibration loads

Information

- Sizes: 26.9 mm – 812.8 mm
- Working pressure: 70.0 bar – 1 bar
- Material: AISI 304, AISI 316 Ti
- EPDM:
 - Sizes from 26.9 mm up to 168.3 mm: -30 °C up to +125 °C
 - Sizes > 180.0 mm: from -20 °C up to +80 °C
- NBR: from -20 °C up to +80 °C
- FKM: -10 °C to +150 °C
(Higher temperatures possible in some cases.)



Materials

W1	W2	W3	W4	W5
	x		x	x

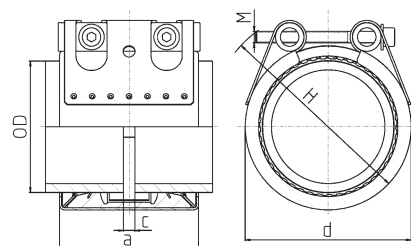
Technical data & Ordering information



Technical data & Ordering information

NORMACONNECT® FGR GRIP E											
Ø (O.D.)	Designation	Clamping ranges	PN ¹	WP ²	C max	Dimensions (approx.)			Weight (approx.)	Hex socket locking bolts	
		O _{dmin} - O _{dmax} (mm)	 [bar]	 [bar]	(mm)	a (mm)	d (mm)	H (mm)	(kg/pc.)	Thread	Tightening torque (Nm)
26.9	Grip E 26.9	26.4 - 27.5	16	70	3	67	50	70	0.32	M 8 SW 6	10
28.0	Grip E 28.0	27.5 - 28.5	16	70	3	67	50	70	0.32	M 8 SW 6	10
30.0	Grip E 30.0	29.5 - 30.6	16	70	3	67	50	70	0.32	M 8 SW 6	10
33.7	Grip E 33.7	33.0 - 34.3	16	60	3	67	55	75	0.33	M 8 SW 6	10
35.0	Grip E 35.0	34.5 - 35.6	16	60	8	63	55	75	0.45	M 8 SW 6	15
38.0	Grip E 38.0	37.5 - 38.6	16	60	8	63	60	80	0.45	M 8 SW 6	15
42.4	Grip E 42.4	41.7 - 43.0	16	50	8	63	65	85	0.46	M 8 SW 6	15
44.5	Grip E 44.5	44.0 - 45.1	16	50	8	63	65	85	0.47	M 8 SW 6	15
48.3	Grip E 48.3	47.6 - 50.5	16	50	8	63	70	90	0.48	M 8 SW 6	15
54.0	Grip E 54.0	53.3 - 54.6	16	50	17	78	75	95	0.62	M 8 SW 6	15
57.0	Grip E 57.0	56.3 - 57.7	16	50	17	78	80	100	0.63	M 8 SW 6	20
60.3	Grip E 60.3	59.5 - 61.0	16	40	17	78	85	105	0.64	M 8 SW 6	20
70.0	Grip E 70.0	69.0 - 71.0	16	40	25	98	90	110	1.21	M 10 SW 8	30
73.0	Grip E 73.0	72.1 - 73.8	16	40	25	98	95	115	1.23	M 10 SW 8	30
76.1	Grip E 76.1	75.2 - 77.0	16	35	25	98	100	120	1.23	M 10 SW 8	30
80.0	Grip E 80.0	79.0 - 80.8	16	35	25	98	100	120	1.27	M 10 SW 8	30
84.0	Grip E 84.0	83.0 - 85.0	16	35	25	98	105	125	1.29	M 10 SW 8	30
88.9	Grip E 88.9	87.0 - 89.9	16	35	25	98	110	130	1.31	M 10 SW 8	30
101.6	Grip E 101.6	100.4 - 102.8	16	35	25	98	125	145	1.45	M 10 SW 8	30
104.0	Grip E 104.0	102.8 - 106.1	16	35	25	98	125	145	1.46	M 10 SW 8	30
108.0	Grip E 108.0	106.8 - 109.2	16	35	25	98	130	150	1.49	M 10 SW 8	30
110.0	Grip E 110.0	108.8 - 111.4	16	35	25	98	130	150	1.54	M 10 SW 8	30
114.3	Grip E 114.3	113.0 - 115.5	16	35	25	98	135	155	1.54	M 10 SW 8	50
129.0	Grip E 129.0	127.6 - 131.1	16	32	35	115	155	185	2.83	M 12 SW 10	50
133.0	Grip E 133.0	131.5 - 134.4	16	32	35	115	160	190	2.93	M 12 SW 10	50
139.7	Grip E 139.7	138.1 - 141.6	16	32	35	115	165	195	3.04	M 12 SW 10	50
141.3	Grip E 141.3	139.6 - 142.8	16	32	35	115	170	200	3.04	M 12 SW 10	50
154.0	Grip E 154.0	152.3 - 156.1	16	32	35	115	180	210	3.17	M 12 SW 10	60
159.0	Grip E 159.0	157.3 - 160.7	16	32	35	115	185	215	3.28	M 12 SW 10	60
168.3	Grip E 168.3	166.5 - 170.1	16	32	35	115	195	225	3.35	M 12 SW 10	60

PN¹ (Nominal Pressure) is the max. admissible working pressure in shipbuilding, based on a safety factor of ≥ 4 .
 WP² is the max. working pressure in industrial applications, with a safety factor as per NORMA specification.

Technical data & Ordering information

NORMACONNECT®

NORMACONNECT® FGR GRIP E								
Ø (O.D.)	Designation	W2 Product No.		W4 Product No.		W5 Product No.		
		EPDM	NBR	EPDM	NBR	EPDM	NBR	FKM
26.9	Grip E 26.9	0579 9100 026	0579 8400 026	0579 9200 026	0579 8500 026	0579 9300 026	0579 8600 026	
28.0	Grip E 28.0	0579 9100 028	0579 8400 028	0579 9200 028	0579 8500 028	0579 9300 028	0579 8600 028	
30.0	Grip E 30.0	0579 9100 030	0579 8400 030	0579 9200 030	0579 8500 030	0579 9300 030	0579 8600 030	
33.7	Grip E 33.7	0579 9100 033	0579 8400 033	0579 9200 033	0579 8500 033	0579 9300 033	0579 8600 033	0579 9900 033
35.0	Grip E 35.0	0579 9100 035	0579 8400 035	0579 9200 035	0579 8500 035	0579 9300 035	0579 8600 035	
38.0	Grip E 38.0	0579 9100 038	0579 8400 038	0579 9200 038	0579 8500 038	0579 9300 038	0579 8600 038	0579 9900 038
42.4	Grip E 42.4	0579 9100 042	0579 8400 042	0579 9200 042	0579 8500 042	0579 9300 042	0579 8600 042	0579 9900 042
44.5	Grip E 44.5	0579 9100 044	0579 8400 044	0579 9200 044	0579 8500 044	0579 9300 044	0579 8600 044	
48.3	Grip E 48.3	0579 9100 048	0579 8400 048	0579 9200 048	0579 8500 048	0579 9300 048	0579 8600 048	0579 9900 048
54.0	Grip E 54.0	0579 9100 054	0579 8400 054	0579 9200 054	0579 8500 054	0579 9300 054	0579 8600 054	
57.0	Grip E 57.0	0579 9100 057	0579 8400 057	0579 9200 057	0579 8500 057	0579 9300 057	0579 8600 057	0579 9900 057
60.3	Grip E 60.3	0579 9100 060	0579 8400 060	0579 9200 060	0579 8500 060	0579 9300 060	0579 8600 060	0579 9900 060
63.0	Grip E 63.0	0579 9100 063	0579 8400 063	0579 9200 063	0579 8500 063	0579 9300 063	0579 8600 063	0579 9900 063
70.0	Grip E 70.0	0579 9100 070	0579 8400 070	0579 9200 070	0579 8500 070	0579 9300 070	0579 8600 070	
73.0	Grip E 73.0	0579 9100 073	0579 8400 073	0579 9200 073	0579 8500 073	0579 9300 073	0579 8600 073	
76.1	Grip E 76.1	0579 9100 076	0579 8400 076	0579 9200 076	0579 8500 076	0579 9300 076	0579 8600 076	0579 9900 076
80.0	Grip E 80.0	0579 9100 080	0579 8400 080	0579 9200 080	0579 8500 080	0579 9300 080	0579 8600 080	
84.0	Grip E 84.0	0579 9100 084	0579 8400 084	0579 9200 084	0579 8500 084	0579 9300 084	0579 8600 084	
88.9	Grip E 88.9	0579 9100 088	0579 8400 088	0579 9200 088	0579 8500 088	0579 9300 088	0579 8600 088	0579 9900 088
101.6	Grip E 101.6	0579 9100 101	0579 8400 101	0579 9200 101	0579 8500 101	0579 9300 101	0579 8600 101	
104.0	Grip E 104.0	0579 9100 104	0579 8400 104	0579 9200 104	0579 8500 104	0579 9300 104	0579 8600 104	
108.0	Grip E 108.0	0579 9100 108	0579 8400 108	0579 9200 108	0579 8500 108	0579 9300 108	0579 8600 108	
110.0	Grip E 110.0	0579 9100 110	0579 8400 110	0579 9200 110	0579 8500 110	0579 9300 110	0579 8600 110	
114.3	Grip E 114.3	0579 9100 114	0579 8400 114	0579 9200 114	0579 8500 114	0579 9300 114	0579 8600 114	0579 9900 114
129.0	Grip E 129.0	0579 9100 129	0579 8400 129	0579 9200 129	0579 8500 129	0579 9300 129	0579 8600 129	0579 9900 129
133.0	Grip E 133.0	0579 9100 133	0579 8400 133	0579 9200 133	0579 8500 133	0579 9300 133	0579 8600 133	
139.7	Grip E 139.7	0579 9100 139	0579 8400 139	0579 9200 139	0579 8500 139	0579 9300 139	0579 8600 139	0579 9900 139
141.3	Grip E 141.3	0579 9100 141	0579 8400 141	0579 9200 141	0579 8500 141	0579 9300 141	0579 8600 141	
154.0	Grip E 154.0	0579 9100 154	0579 8400 154	0579 9200 154	0579 8500 154	0579 9300 154	0579 8600 154	
159.0	Grip E 159.0	0579 9100 159	0579 8400 159	0579 9200 159	0579 8500 159	0579 9300 159	0579 8600 159	
168.3	Grip E 168.3	0579 9100 168	0579 8400 168	0579 9200 168	0579 8500 168	0579 9300 168	0579 8600 168	0579 9900 168



NORMACONNECT® GRIP axial restraint pipe couplings are used to connect metal pipes.

Material

W2, W4, W5

NORMACONNECT® FGR GRIP											
Ø (O.D.)	Designation	Clamping ranges	PN ¹	WP ²	C max	Dimensions (approx.)			Weight (approx.) (kg/pc.)	Hex socket locking bolts	
						O _{dmin} - O _{dmax} (mm)	 [bar]	 [bar]		(mm)	a (mm)
193.7	Grip 193.7	192.0 - 196.0	16	32	35	142	225	255	6.8	M 16 SW 14	150
206.0	Grip 206.0	202.0 - 208.0	16	32	35	142	240	270	7.0	M 16 SW 14	150
219.1	Grip 219.1	216.0 - 221.0	16	32	35	142	250	280	7.3	M 16 SW 14	150
225.0	Grip 225.0	222.0 - 227.0	13	26.5	35	142	255	285	7.4	M 16 SW 14	180
229.9	Grip 229.9	228.0 - 232.0	13	26	35	142	260	290	7.5	M 16 SW 14	180
244.5	Grip 244.5	242.0 - 247.0	12	24.5	35	142	275	305	7.7	M 16 SW 14	180
254.0	Grip 254.0	250.0 - 256.0	11.5	22.5	35	142	285	315	7.9	M 16 SW 14	180
267.0	Grip 267.0	264.0 - 269.0	11	22.5	35	142	300	330	8.2	M 16 SW 14	180
273.0	Grip 273.0	270.0 - 275.0	11	22	35	142	305	335	8.3	M 16 SW 14	180
306.0	Grip 306.0	302.0 - 308.0	9.5	19.5	35	142	340	370	8.9	M 16 SW 14	180
323.9	Grip 323.9	320.0 - 327.0	6.5	13	35	142	355	385	9.2	M 16 SW 14	180
326.0	Grip 326.0	322.0 - 329.0	6.5	13	35	142	360	390	9.3	M 16 SW 14	180
355.6	Grip 355.6	352.0 - 359.0	6	12	35	142	390	420	9.8	M 16 SW 14	180
406.4	Grip 406.4	402.0 - 410.0	4.5	9	35	142	440	470	10.8	M 16 SW 14	180
429.0	Grip 429.0	426.0 - 431.0	4	8.5	35	142	460	490	11.3	M 16 SW 14	180
442.0	Grip 442.0	439.0 - 444.0	4	8	35	142	475	505	11.5	M 16 SW 14	180
457.2	Grip 457.2	454.0 - 459.0	4	8	35	142	490	520	11.8	M 16 SW 14	180
508.0	Grip 508.0	505.0 - 510.0	2.5	5	35	142	540	570	12.7	M 16 SW 14	180
531.0	Grip 531.0	528.0 - 534.0	2.5	5	35	142	565	595	13.2	M 16 SW 14	180
558.8	Grip 558.8	556.0 - 562.0	2	4.5	35	142	590	620	13.7	M 16 SW 14	180
609.6	Grip 609.6	606.0 - 613.0	1.5	3	35	142	640	670	14.7	M 16 SW 14	180
634.0	Grip 634.0	631.0 - 637.0	1.5	3	35	142	665	695	15.1	M 16 SW 14	200
711.2	Grip 711.2	707.0 - 715.0	1.5	2.5	35	142	745	775	16.6	M 16 SW 14	200

PN¹ (Nominal Pressure) is the max. admissible working pressure in shipbuilding, based on a safety factor of ≥ 4 .

WP² is the max. working pressure in industrial applications, with a safety factor as per NORMA specification.

Technical data & Ordering information

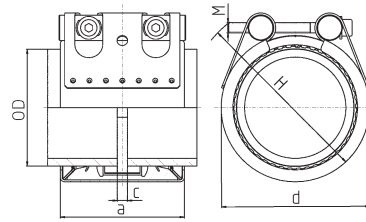

NORMACONNECT® FGR GRIP							
Ø (O.D.)	Designation	W2 Product No.		W4 Product No.		W5 Product No.	
		EPDM	NBR	EPDM	NBR	EPDM	NBR
193.7	Grip 193.7	0577 8100 193	0577 8400 193	0577 8200 193	0577 8500 193	0577 8300 193	0577 8600 193
206.0	Grip 206.0	0577 8100 206	0577 8400 206	0577 8200 206	0577 8500 206	0577 8300 206	0577 8600 206
219.1	Grip 219.1	0577 8100 219	0577 8400 219	0577 8200 219	0577 8500 219	0577 8300 219	0577 3600 219
225.0	Grip 225.0	0577 8100 225	0577 8400 225	0577 8200 225	0577 8500 225	0577 8300 225	0577 8600 225
229.9	Grip 229.9	0577 8100 229	0577 8400 229	0577 8200 229	0577 8500 229	0577 8300 229	0577 8600 229
244.5	Grip 244.5	0577 8100 244	0577 8400 244	0577 8200 244	0577 8500 244	0577 8300 244	0577 8600 244
254.0	Grip 254.0	0577 8100 254	0577 8400 254	0577 8200 254	0577 8500 254	0577 8300 254	0577 8600 254
267.0	Grip 267.0	0577 8100 267	0577 8400 267	0577 8200 267	0577 8500 267	0577 8300 267	0577 8600 267
273.0	Grip 273.0	0577 8100 273	0577 8400 273	0577 8200 273	0577 8500 273	0577 8300 273	0577 3600 273
306.0	Grip 306.0	0577 8100 306	0577 8400 306	0577 8200 306	0577 8500 306	0577 8300 306	0577 8600 306
323.9	Grip 323.9	0577 8100 323	0577 8400 323	0577 8200 323	0577 8500 323	0577 8300 323	0577 8600 323
326.0	Grip 326.0	0577 8100 326	0577 8400 326	0577 8200 326	0577 8500 326	0577 8300 326	0577 8600 326
355.6	Grip 355.6	0577 8100 355	0577 8400 355	0577 8200 355	0577 8500 355	0577 8300 355	0577 8600 355
406.4	Grip 406.4	0577 8100 406	0577 8400 406	0577 8200 406	0577 8500 406	0577 8300 406	0577 8600 406
429.0	Grip 429.0	0577 8100 429	0577 8400 429	0577 8200 429	0577 8500 429	0577 8300 429	0577 8600 429
442.0	Grip 442.0	0577 8100 442	0577 8400 442	0577 8200 442	0577 8500 442	0577 8300 442	0577 8600 442
457.2	Grip 457.2	0577 8100 457	0577 8400 457	0577 8200 457	0577 8500 457	0577 8300 457	0577 8600 457
508.0	Grip 508.0	0577 8100 508	0577 8400 508	0577 8200 508	0577 8500 508	0577 8300 508	0577 8600 508
531.0	Grip 531.0	0577 8100 531	0577 8400 531	0577 8200 531	0577 8500 531	0577 8300 531	0577 8600 531
558.8	Grip 558.8	0577 8100 558	0577 8400 558	0577 8200 558	0577 8500 558	0577 8300 558	0577 8600 558
609.6	Grip 609.6	0577 8100 609	0577 8400 609	0577 8200 609	0577 8500 609	0577 8300 609	0577 8600 609
634.0	Grip 634.0	0577 8100 634	0577 8400 634	0577 8200 634	0577 8500 634	0577 8300 634	0577 8600 634
711.2	Grip 711.2	0577 8100 711	0577 8400 711	0577 8200 711	0577 8500 711	0577 8300 711	0577 8600 711

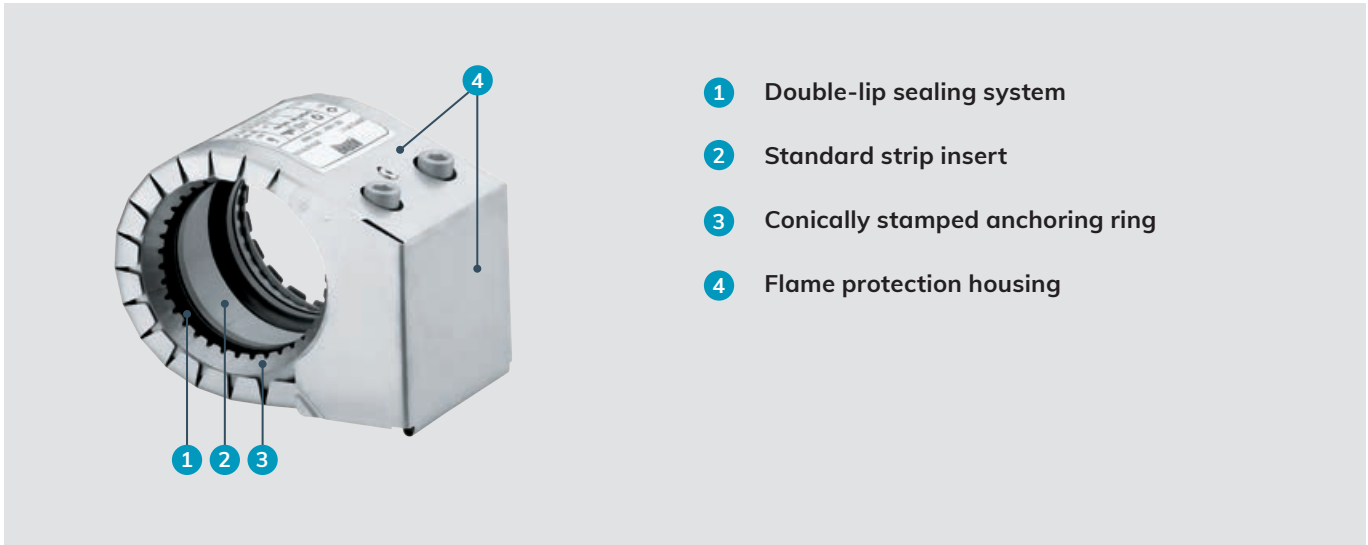

- 1 Double-lip sealing system
- 2 Standard strip insert
- 3 Conically stamped anchoring ring
- 4 Flame protection housing

The fire resistant coupling

NORMACONNECT® GRIP E-FP pipe couplings with integrated flame protection are used with applications in the marine sector (civil and military) as well as in sprinkler systems. For this purpose the GRIP E type has been equipped with an additional housing made from stainless steel plus a fire-resistant lining which can resist temperatures of 850 °C and upwards.

Advantages at a glance

- ✓ Dampens absorbing vibrations, pressure surges
- ✓ Weight saving
- ✓ Tension free
- ✓ Ready to install

Information

- Sizes: 26.9 mm – 219.1 mm
- Working pressure: 16.0 – 6.0 bar
- Material: AISI 304, AISI 316 Ti
- EPDM:
 - Sizes from 26.9 mm up to 168.3 mm: -30 °C up to +125 °C
 - Sizes > 180.0 mm: from -20 °C up to +80 °C
- NBR: from -20 °C up to +80 °C

Materials

W1	W2	W3	W4	W5
				x

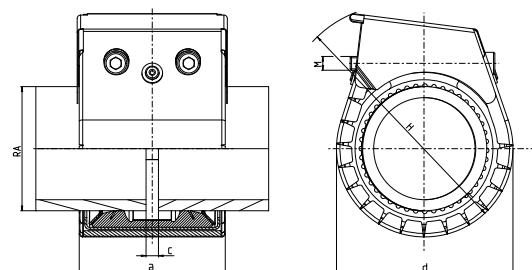

Technical data & ordering information



FGR GRIP E-FP (FLAME PROTECTED)

Technical data & Ordering information

NORMACONNECT®

NORMACONNECT® FGR GRIP E-FP													
Ø (O.D.)	Designation	Clamping ranges	PN ¹ (MAWP ¹ from dia- meter 180)	WP ¹	C max	Dimensions (approx.)			Weight (approx.)	Hex socket locking bolts		W5 Product No.	
			Odmin - Odmax (mm)	 [bar]	 [bar]	(mm)	a (mm)	d (mm)	H (mm)	(kg/pc.)	Thread	Tightening torque (Nm)	EPDM
26.9	Grip E-FP 26.9	26.4 - 27.5	16	70	3	67	60	110	0.42	M 8 SW 6	10	0579 9370 026	0579 8670 026
28.0	Grip E-FP 28.0	27.5 - 28.5	16	70	3	67	60	110	0.42	M 8 SW 6	10	0579 9370 028	0579 8670 028
30.0	Grip E-FP 30.0	29.5 - 30.6	16	70	3	67	60	110	0.42	M 8 SW 6	10	0579 9370 030	0579 8670 030
33.7	Grip E-FP 33.7	33.0 - 34.3	16	60	3	67	65	115	0.43	M 8 SW 6	10	0579 9370 033	0579 8670 033
35.0	Grip E-FP 35.0	34.5 - 35.6	16	60	8	75	65	115	0.58	M 8 SW 6	15	0579 9370 035	0579 8670 035
38.0	Grip E-FP 38.0	37.5 - 38.6	16	60	8	75	70	120	0.58	M 8 SW 6	15	0579 9370 038	0579 8670 038
42.4	Grip E-FP 42.4	41.7 - 43.0	16	50	8	75	75	125	0.59	M 8 SW 6	15	0579 9370 042	0579 8670 042
44.5	Grip E-FP 44.5	44.0 - 45.1	16	50	8	75	75	125	0.60	M 8 SW 6	15	0579 9370 044	0579 8670 044
48.3	Grip E-FP 48.3	47.6 - 50.5	16	50	8	75	80	130	0.61	M 8 SW 6	15	0579 9370 048	0579 8670 048
54.0	Grip E-FP 54.0	53.3 - 54.6	16	50	17	90	85	135	0.92	M 8 SW 6	15	0579 9370 054	0579 8670 054
57.0	Grip E-FP 57.0	56.3 - 57.7	16	50	17	90	90	140	0.93	M 8 SW 6	20	0579 9370 057	0579 8670 057
60.3	Grip E-FP 60.3	59.5 - 61.0	16	40	17	90	95	145	0.94	M 8 SW 6	20	0579 9370 060	0579 8670 060
73.0	Grip E-FP 73.0	72.1 - 73.8	16	40	17	90	95	145	0.94	M 10 SW 8	30	0579 9370 073	0579 8670 073
76.1	Grip E-FP 76.1	75.2 - 77.0	16	35	25	110	105	155	1.49	M 10 SW 8	30	0579 9370 076	0579 8670 076
84.0	Grip E-FP 84.0	83.0 - 85.0	16	35	25	110	110	160	1.49	M 10 SW 8	30	0579 9370 084	0579 8670 084
88.9	Grip E-FP 88.9	87.0 - 89.9	16	35	25	110	115	165	1.56	M 10 SW 8	30	0579 9370 088	0579 8670 088
101.6	Grip E-FP 101.6	100.4 - 102.8	16	35	25	110	120	170	1.59	M 10 SW 8	30	0579 9370 101	0579 8670 101
104.0	Grip E-FP 104.0	102.8 - 106.1	16	35	25	110	135	185	1.75	M 10 SW 8	30	0579 9370 104	0579 8670 104
108.0	Grip E-FP 108.0	106.8 - 109.2	16	35	25	110	135	185	1.76	M 10 SW 8	30	0579 9370 108	0579 8670 108
110.0	Grip E-FP 110.0	108.8 - 111.4	16	35	25	110	140	190	1.79	M 10 SW 8	30	0579 9370 110	0579 8670 110
114.3	Grip E-FP 114.3	113.0 - 115.5	16	35	25	110	145	195	1.89	M 10 SW 8	40	0579 9370 114	0579 8670 114
129.0	Grip E-FP 129.0	127.6 - 131.1	16	32	35	125	165	215	3.25	M 12 SW 10	50	0579 9370 129	0579 8670 129
133.0	Grip E-FP 133.0	131.5 - 134.4	16	32	35	125	170	220	3.36	M 12 SW 10	50	0579 9370 133	0579 8670 133
139.7	Grip E-FP 139.7	138.1 - 141.6	16	32	35	125	175	225	3.48	M 12 SW 10	50	0579 9370 139	0579 8670 139
141.3	Grip E-FP 141.3	139.6 - 142.8	16	32	35	125	180	230	3.48	M 12 SW 10	50	0579 9370 141	0579 8670 141
154.0	Grip E-FP 154.0	152.3 - 156.1	16	32	35	125	190	240	3.63	M 12 SW 10	60	0579 9370 154	0579 8670 154
159.0	Grip E-FP 159.0	157.3 - 160.7	16	32	35	125	195	245	3.75	M 12 SW 10	60	0579 9370 159	0579 8670 159
168.3	Grip E-FP 168.3	166.5 - 170.1	16	32	35	125	205	255	3.83	M 12 SW 10	60	0579 9370 168	0579 8670 168
193.7	Grip E-FP 193.7	192.0 - 196.0	10	20	35	125	235	285	6.9	M 16 SW 14	100	0579 9370 193	0579 8670 193
206.0	Grip E-FP 206.0	202.0 - 208.0	10	20	35	125	250	300	7.2	M 16 SW 14	100	0579 9370 206	0579 8670 206
219.1	Grip E-FP 219.1	216.0 - 221.0	10	20	35	125	260	310	7.4	M 16 SW 14	100	0574 8370 219	0574 8670 219

PN¹ (Nominal Pressure) is the max. admissible working pressure in shipbuilding, based on a safety factor of ≥ 4 .
 MAWP¹ (Maximum Allowable Working Pressure) is the max. admissible working pressure in shipbuilding, based on a safety factor of ≥ 4 .
 WP² is the max. working pressure in industrial applications, with a safety factor as per NORMA specification.
 Bigger dimensions available on request.



- 1 Metal housing made of AISI 316 Ti
- 2 Environmentally-friendly – No use of chemicals
- 3 Shoulders of the coupling are flame protected



Double-locked safeguards prevent accidental dismantling

RFP for application at shipbuilding

The NORMACONNECT® RFP is a retrofittable flame protector housing that has been specially designed for use with all NORMACONNECT® FLEX and GRIP pipe couplings. Its low weight and straightforward design allows quick, easy assembly without any tools. The built-in flame resistant mineral fiber mat provides a premium level of flame protection. The Retrofit Flame Protector (RFP) housing has been extensively tested and is approved by several international classification societies.

Advantages at a glance

- ✓ Retrofittable
- ✓ Easy assembly without tooling
- ✓ Low weight
- ✓ Meets current IACS requirements
- ✓ No chemicals in flame protection mat
- ✓ High flexibility
- ✓ Clear identification whether coupling is flame protected or not
- ✓ Mechanical stress resistant
- ✓ Less warehouse costs

Information

Sizes from 26.9 mm up to 273.0 mm

Materials

W1	W2	W3	W4	W5
				x

Technical data & Ordering information

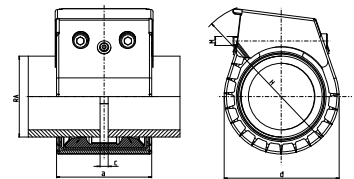

NORMACONNECT® FGR RFP						
Ø (O.D.)	Designation	Dimensions (approx.)			Weight of RFP (approx.) (kg/piece)	W5 Product No.
		a (mm)	d (mm)	H* (mm)		
26.9	NC RFP W5 RFP 26.9	69	60	110	0.09	0573 0000 026
28.0	NC RFP W5 RFP 28.0	69	60	110	0.09	0573 0000 028
30.0	NC RFP W5 RFP 30.0	69	60	110	0.10	0573 0000 030
33.7	NC RFP W5 RFP 33.7	69	65	115	0.10	0573 0000 033
38.0	NC RFP W5 RFP 38.0	75	70	120	0.11	0573 0000 038
42.4	NC RFP W5 RFP 42.4	75	75	125	0.12	0573 0000 042
44.5	NC RFP W5 RFP 44.5	75	75	125	0.12	0573 0000 044
48.3	NC RFP W5 RFP 48.3	75	80	130	0.13	0573 0000 048
54.0	NC RFP W5 RFP 54.0	90	90	135	0.14	0573 0000 054
57.0	NC RFP W5 RFP 57.0	90	90	140	0.16	0573 0000 057
60.3	NC RFP W5 RFP 60.3	90	95	145	0.16	0573 0000 060
76.1	NC RFP W5 RFP 76.1	110	110	160	0.24	0573 0000 076
88.9	NC RFP W5 RFP 88.9	110	120	170	0.26	0573 0000 088
101.6	NC RFP W5 RFP 101.6	110	135	185	0.28	0573 0000 101
104.0	NC RFP W5 RFP 104.0	110	135	185	0.29	0573 0000 104
108.0	NC RFP W5 RFP 108.0	110	140	190	0.30	0573 0000 108
114.3	NC RFP W5 RFP 114.3	110	145	195	0.31	0573 0000 114
133.0	NC RFP W5 RFP 133.0	125	170	220	0.41	0573 0000 133
139.7	NC RFP W5 RFP 139.7	125	175	225	0.43	0573 0000 139
154.0	NC RFP W5 RFP 154.0	125	190	240	0.45	0573 0000 154
159.0	NC RFP W5 RFP 159.0	125	195	245	0.49	0573 0000 159
168.3	NC RFP W5 RFP 168.3	125	205	255	0.50	0573 0000 168
219.1	NC RFP W5 RFP 219.1	155	260	310	0.73	0573 0000 219

* Dimensions of the housing are given as assembled on a NORMACONNECT® Grip / Grip E / Flex / Flex E pipe coupling. Further sizes available on request.



- 1 Double-lip sealing system
- 2 Standard strip insert
- 3 Anchoring ring

The coupling for plastic pipes

NORMACONNECT® PLAST GRIP/PLAST GRIP E axial restraint pipe couplings are used to connect plastic pipes. The specially designed anchoring ring, featuring flat rows of teeth, engages into the pipe surface without damaging the plastic material. The force applied is distributed evenly across the pipe surface. NORMACONNECT® PLAST GRIP E has hollow trunnions (smaller diameters). NORMACONNECT® PLAST GRIP has solid trunnions (larger diameters).

Advantages at a glance

- ✓ Also usable for smooth thermoplastics such as PP and PE.
- ✓ Also available with hollow trunnions for weight-saving

Information

- Sizes: 40.0 mm – 400.0 mm
- Working pressure: 16.0 – 6.0 bar
- Material: AISI 304, AISI 316 Ti
- EPDM:
 - Sizes from 40.0 mm up to 168.3 mm -30 °C up to +125 °C
 - Sizes > 180.0 mm: -20 °C up to +80 °C
- NBR: -20 °C up to +80 °C

Materials

W1	W2	W3	W4	W5
				x

Technical data & ordering information

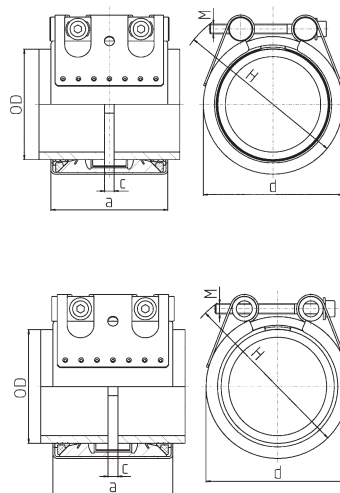



NORMACONNECT® PLAST GRIP/PLAST GRIP E axial restraint pipe couplings are used to connect plastic pipes.

Main advantage

- PLAST GRIP E has hollow trunnions and is weight-saving (available for smaller diameters)
- PLAST GRIP has solid trunnions (available for larger diameters)

Material

W5

Technical data & Ordering information

NORMACONNECT® FGR PLAST GRIP E													
Ø (O.D.)	Designation	Clamping ranges	PN ¹	WP ²	C max	Dimensions (approx.)			Weight (approx.)	Hex socket locking bolts		W5 Product No.	
		Oadmin - Odmx (mm)	[bar]	[bar]	(mm)	a (mm)	d (mm)	H (mm)	(kg/pc.)	Thread	Tightening torque (Nm)	EPDM	NBR
40.0	Plast Grip E W5 40	39.0 - 40.5	10	16	8	62	60	80	0.48	M 8 SW 6	15	0581 9360 040	0581 8660 040
50.0	Plast Grip E W5 50	49.0 - 50.5	10	16	8	62	70	90	0.52	M 8 SW 6	15	0581 9360 050	0581 8660 050
63.0	Plast Grip E W5 63	62.0 - 63.5	10	16	17	78	85	105	0.67	M 8 SW 6	20	0581 9360 063	0581 8660 063
75.0	Plast Grip E W5 75	74.0 - 76.0	10	16	25	98	100	120	1.33	M 10 SW 8	30	0581 9360 075	0581 8660 075
90.0	Plast Grip E W5 90	89.0 - 91.0	10	16	25	98	110	130	1.42	M 10 SW 8	30	0581 9360 090	0581 8660 090
110.0	Plast Grip E W5 110	109.0 - 111.0	10	16	25	98	130	150	1.66	M 10 SW 8	30	0581 9360 110	0581 8660 110
125.0	Plast Grip E W5 125	124.0 - 126.0	10	16	35	115	140	160	1.42	M 12 SW 10	40	0581 9360 125	0581 8660 125
140.0	Plast Grip E W5 140	139.0 - 141.0	10	16	35	115	160	180	1.18	M 12 SW 10	50	0581 9360 140	0581 8660 140
154.0	Plast Grip E W5 154	152.3 - 156.1	10	16	35	115	170	190	1.27	M 12 SW 10	50	0581 9360 154	0581 8660 154
160.0	Plast Grip E W5 160	159.0 - 162.0	10	16	35	115	180	200	1.45	M 12 SW 10	60	0581 9360 160	0581 8660 160

NORMACONNECT® FGR PLAST GRIP													
Ø (O.D.)	Designation	Clamping ranges	PN ¹	WP ²	C max	Dimensions (approx.)			Weight (approx.)	Hex socket locking bolts		W5 Product No.	
		Oadmin - Odmx (mm)	[bar]	[bar]	(mm)	a (mm)	d (mm)	H (mm)	(kg/pc.)	Thread	Tightening torque (Nm)	EPDM	NBR
180.0	Plast Grip W5 180	178.0 - 182.0	-	16	35	142	210	240	7.6	M 12 SW 10	60	0581 8350 180	0581 8650 180
200.0	Plast Grip W5 200	198.0 - 202.0	-	16	35	142	230	260	8.1	M 12 SW 10	60	0581 8350 200	0581 8650 200
225.0	Plast Grip W5 225	222.0 - 227.0	-	10	35	142	255	285	8.7	M 12 SW 10	60	0581 8350 225	0581 8650 225
250.0	Plast Grip W5 250	247.0 - 253.0	-	10	35	142	280	310	9.4	M 12 SW 10	80	0581 8350 250	0581 8650 250
280.0	Plast Grip W5 280	277.0 - 283.0	-	10	35	142	310	340	10.1	M 16 SW 14	100	0581 8350 280	0581 8650 280
315.0	Plast Grip W5 315	311.0 - 318.0	-	10	35	142	345	375	11	M 16 SW 14	100	0581 8350 315	0581 8650 315
355.0	Plast Grip W5 355	352.0 - 359.0	-	6	35	142	385	415	12	M 16 SW 14	120	0581 8350 355	0581 8650 355
400.0	Plast Grip W5 400	396.0 - 404.0	-	6	35	142	430	460	13.1	M 16 SW 14	120	0581 8350 400	0581 8650 400

PN¹ (Nominal Pressure) is the max. admissible working pressure in shipbuilding, based on a safety factor of ≥ 4.
 WP² is the max. working pressure in industrial applications, with a safety factor as per NORMA specification.



- 1 Double-lip sealing system
- 2 Standard strip insert
- 3 Anchoring ring

The combining pipe coupling

NORMACONNECT® COMBI GRIP/COMBI GRIP E axial restraint pipe couplings are used to connect plastic pipes with metal pipes.

On the side connecting the plastic pipe, the coupling has a special anchoring ring with rows of flat teeth which are pressed into the pipe surface without damaging the material. At the same time the force applied is distributed evenly across the pipe surface.

On the side connecting the metal pipe, the coupling has a different anchoring ring with conically stamped teeth which grip into the pipe surface. Due to the special design of the anchoring ring the coupling can withstand even high vibration loads. NORMACONNECT® COMBI GRIP E has hollow trunnions (smaller diameters). NORMACONNECT® COMBI GRIP has solid trunnions (larger diameters).

Advantages at a glance

- ✓ Corrosion resistant
- ✓ No welding
- ✓ No special tools necessary
- ✓ Installation and working in every kind of weather (hot and cold)
- ✓ Reusable

Information

- Sizes: from 38.0/40.0 mm to 400.0/406.0 mm
- Working pressure: 16.0 – 6.0 bar
- Material: AISI 304, AISI 316 Ti
- EPDM:
 - Sizes from 38.0 mm up to 160.0 mm: -30 °C up to +125 °C
 - Sizes > 200.0 mm: -20 °C up to +80 °C
- NBR: from -20 °C up to +80 °C

Materials

W1	W2	W3	W4	W5
				x

Technical data & Ordering information

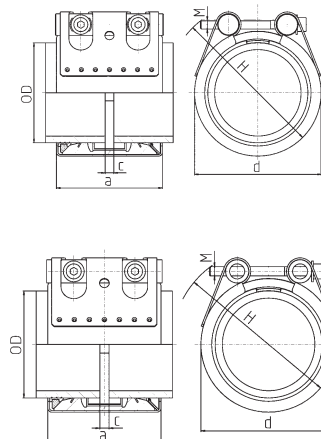



NORMACONNECT® COMBI GRIP/COMBI GRIP E axial restraint pipe couplings are used to connect plastic pipes with metal pipes.



Advantages at a glance



- COMBI GRIP E has hollow trunnions (smaller diameters)
- COMBI GRIP has solid trunnions (larger diameters)

Material

W5

Technical data & Ordering information

NORMACONNECT® FGR COMBI GRIP E														
Ø (O.D.)	Designation	Clamping ranges Odmin - Odmax (mm)		PN ¹  [bar]	WP ²  [bar]	C max (mm)	Dimensions (approx.)			Weight (approx.) (kg/pc.)	Hex socket locking bolts		W5 Product No.	
		Plastic	Metal				a (mm)	d (mm)	H (mm)		Thread	Tight- ening torque (Nm)	EPDM	NBR
38.0 / 40.0	Combi Grip E 38.0 / 40.0	39.0-40.5	37.5-38.6	10	16	8	62	60	80	0.46	M 8 SW 6	15	0584 9360 038	0584 8660 038
40.0 / 42.4	Combi Grip E 40.0 / 42.4	39.0-40.5	41.7-43.0	10	16	8	62	65	85	0.47	M 8 SW 6	15	0584 9360 042	0584 8660 042
50.0 / 48.3	Combi Grip E 50.0 / 48.3	47.6-51.0	47.6-50.5	10	16	8	62	70	90	0.5	M 8 SW 6	15	0584 9360 048	0584 8660 048
56.0 / 54.0*	Combi Grip E 56.0 / 54.0	55.0-56.5	53.3-54.6	-	5*	17	78	80	100	0.62	M 8 SW 6	15	0584 9360 054	0584 8660 054
63.0 / 60.3	Combi Grip E 63.0 / 60.3	62.0-63.5	59.5-61.0	10	16	17	78	85	105	0.65	M 8 SW 6	20	0584 9360 060	0584 8660 060
75.0 / 76.1	Combi Grip E 75.0 / 76.1	74.0-76.0	75.2-77.0	10	16	25	98	100	120	1.3	M 10 SW 8	30	0584 9360 076	0584 8660 076
90.0 / 88.9	Combi Grip E 90.0 / 88.9	89.0-91.0	87.0-89.9	10	16	25	98	110	130	1.39	M 10 SW 8	30	0584 9360 088	0584 8660 088
110.0 / 108.0	Combi Grip E 110.0 / 108.0	109.0-111.0	106.8-109.2	10	16	25	98	130	150	1.58	M 10 SW 8	40	0584 9360 108	0584 8660 108
110.0 / 114.3	Combi Grip E 110.0 / 114.3	109.0-111.0	113.0-115.5	10	16	25	98	135	155	1.62	M 10 SW 8	40	0584 9360 110	0584 8660 110
140.0 / 139.7	Combi Grip E 140.0 / 139.7	139.0-141.0	138.1-141.6	10	16	35	115	160	180	3.14	M 12 SW 10	50	0584 9360 139	0584 8660 139
160.0 / 159.0	Combi Grip E 159.0 / 160.0	159.0-162.0	157.3-160.7	10	16	35	115	180	200	3.45	M 12 SW 10	60	0584 9360 159	0584 8660 159

NORMACONNECT® FGR COMBI GRIP														
Ø (O.D.)	Designation	Clamping ranges Odmin - Odmax (mm)		PN ¹  [bar]	WP ²  [bar]	C max (mm)	Dimensions (approx.)			Weight (approx.) (kg/pc.)	Hex socket locking bolts		W5 Product No.	
		Plastic	Metal				a (mm)	d (mm)	H (mm)		Thread	Tight- ening torque (Nm)	EPDM	NBR
200.0 / 204.0	Combi Grip 200.0 / 204.0	198.0-202.0	202.0-206.0	-	16	35	142	235	265	7.5	M 12 SW 10	60	0584 8350 204	0584 8650 204
225.0 / 219.1	Combi Grip 225.0 / 219.1	222.0-227.0	216.0-221.0	-	10	35	142	255	285	8.1	M 12 SW 10	60	0584 8350 220	0584 8650 220
225.0 / 222.0	Combi Grip 225.0 / 222.0	222.0-227.0	220.0-224.0	-	10	35	142	255	285	8.1	M 12 SW 10	60	0584 8350 222	0584 8650 222
250.0 / 254.0	Combi Grip 250.0 / 254.0	247.0-253.0	250.0-256.0	-	10	35	142	285	315	8.6	M 12 SW 10	80	0584 8350 254	0584 8650 254
280.0 / 273.0	Combi Grip 280.0 / 273.0	277.0-283.0	270.0-275.0	-	10	35	142	310	340	9.3	M 16 SW 14	100	0584 8350 273	0584 8650 273
355.0 / 355.6	Combi Grip 355.0 / 355.6	351.0-359.0	352.0-359.0	-	6	35	142	390	420	10.9	M 16 SW 14	120	0584 8350 355	0584 8650 355
400.0 / 406.4	Combi Grip 400.0 / 406.4	396.0-404.0	402.0-410.0	-	6	35	142	440	470	11.9	M 16 SW 14	120	0584 8350 400	0584 8650 400

PN¹ (Nominal Pressure) is the max. admissible working pressure in shipbuilding, based on a safety factor of ≥ 4.

WP² is the max. working pressure in industrial applications, with a safety factor as per NORMA specification.

* Special coupling for joining metal pipes with PE-HD drainage pipes

FGR SUPPORT SLEEVE



Support sleeve to be used with NORMACONNECT® PLAST GRIP/PLAST GRIP E, COMBI GRIP GRIP E in W5 (316Ti) material.

For copper and CuNiFe pipes an optional support sleeve made from brass is available on request.

Optional support sleeve

When joining plastic pipes made from PE and PP a support sleeve must be used. If the pipes to be joined are made from soft thermoplastic (e.g., PE) the use of a support sleeve is mandatory. The support sleeve is inserted into the pipe end within the area to be joined and thus protects the pipe from being deformed.

Technical data & Ordering information

INTERNAL SUPPORT SLEEVE FOR PLAST GRIP / PLAST GRIP E IN W5 (316Ti)*						
PE	SDR 11		SDR 13.6		SDR 17	
Ø OD mm	Product No.	Ø mm	Product No.	Ø mm	Product No.	Ø mm
40	0581 0011 040	32.6	0581 0013 040	34.0	0581 0017 040	35.2
50	0581 0011 050	40.8	0581 0013 050	42.6	0581 0017 050	44.0
63	0581 0011 063	51.4	0581 0013 063	53.6	0581 0017 063	55.4
75	0581 0011 075	61.4	0581 0013 075	63.8	0581 0017 075	66.0
90	0581 0011 090	73.6	0581 0013 090	76.6	0581 0017 090	79.2
110	0581 0011 110	90.0	0581 0013 110	93.8	0581 0017 110	96.8
125	0581 0011 125	102.2	0581 0013 125	106.6	0581 0017 125	110.2
140	0581 0011 140	114.6	0581 0013 140	119.4	0581 0017 140	123.4
160	0581 0011 160	130.8	0581 0013 160	136.4	0581 0017 160	141.0
180	0581 0011 180	147.2	0581 0013 180	153.4	0581 0017 180	158.6
200	0581 0011 200	163.6	0581 0013 200	170.6	0581 0017 200	176.2
225	0581 0011 225	184.0	0581 0013 225	191.8	0581 0017 225	198.2
250	0581 0011 250	204.6	0581 0013 250	213.2	0581 0017 250	220.4
280	0581 0011 280	229.2	0581 0013 280	238.8	0581 0017 280	246.8
315	0581 0011 315	257.8	0581 0013 315	268.6	0581 0017 315	277.6
355	0581 0011 355	290.6	0581 0013 355	302.8	0581 0017 355	312.8
400	0581 0011 400	327.4	0581 0013 400	341.2	0581 0017 400	352.6
450	0581 0011 450		0581 0013 450		0581 0017 450	

Table continues on next page
* Other SDR classes on request.

Technical data & Ordering information

INTERNAL SUPPORT SLEEVE FOR PLAST GRIP / PLAST GRIP E IN W5 (316TI)*				
PE	SDR 17.6		SDR 21	
Ø OD mm	Product No.	Ø mm	Product No.	Ø mm
40	0581 0018 040	35.4	0581 0021 040	36.0
50	0581 0018 050	44.2	0581 0021 050	45.2
63	0581 0018 063	55.8	0581 0021 063	57.0
75	0581 0018 075	66.4	0581 0021 075	67.8
90	0581 0018 090	79.8	0581 0021 090	81.4
110	0581 0018 110	97.4	0581 0021 110	99.4
125	0581 0018 125	110.8	0581 0021 125	113.0
140	0581 0018 140	124.0	0581 0021 140	126.6
160	0581 0018 160	141.8	0581 0021 160	144.6
180	0581 0018 180	159.6	0581 0021 180	162.8
200	0581 0018 200	177.2	0581 0021 200	180.8
225	0581 0018 225	199.4	0581 0021 225	203.4
250	0581 0018 250	221.6	0581 0021 250	226.2
280	0581 0018 280	248.2	0581 0021 280	253.2
315	0581 0018 315	279.2	0581 0021 315	285.0
355	0581 0018 355	314.8	0581 0021 355	321.2
400	0581 0018 400	354.6	0581 0021 400	361.8
450	0581 0018 450	399.0	0581 0021 450	407.0

* Other SDR classes on request

INTERNAL SUPPORT SLEEVE FOR PLAST GRIP / PLAST GRIP E IN W5 (316TI)*						
PP	SDR 11		SDR 17		SDR 17.6	
Ø OD mm	Product No.	Ø mm	Product No.	Ø mm	Product No.	Ø mm
40	0581 1011 040	32.6	0581 1017 040	35.2	0581 1018 040	35.4
50	0581 1011 050	40.8	0581 1017 050	44.0	0581 1018 050	44.2
63	0581 1011 063	51.4	0581 1017 063	55.4	0581 1018 063	55.8
75	0581 1011 075	61.4	0581 1017 075	66.0	0581 1018 075	66.4
90	0581 1011 090	73.6	0581 1017 090	79.2	0581 1018 090	79.8
110	0581 1011 110	90.0	0581 1017 110	96.8	0581 1018 110	97.4
125	0581 1011 125	102.2	0581 1017 125	110.2	0581 1018 125	110.8
140	0581 1011 140	114.6	0581 1017 140	123.4	0581 1018 140	124.0
160	0581 1011 160	130.8	0581 1017 160	141.0	0581 1018 160	141.8
180	0581 1011 180	147.2	0581 1017 180	158.6	0581 1018 180	159.6
200	0581 1011 200	163.6	0581 1017 200	176.2	0581 1018 200	177.2
225	0581 1011 225	184.0	0581 1017 225	198.2	0581 1018 225	199.4
250	0581 1011 250	204.6	0581 1017 250	220.4	0581 1018 250	221.6
280	0581 1011 280	229.2	0581 1017 280	246.8	0581 1018 280	248.2
315	0581 1011 315	257.8	0581 1017 315	277.6	0581 1018 315	279.2
355	0581 1011 355	290.6	0581 1017 355	312.8	0581 1018 355	314.8
400	0581 1011 400	327.4	0581 1017 400	352.6	0581 1018 400	354.6
450	0581 1011 450	368.2	0581 1017 450	396.6	0581 1018 450	399.0

* Other SDR classes on request



- 1 Double-lip sealing system
- 2 Standard strip insert

The repair coupling

NORMACONNECT® REP E are non-restraint repair couplings. They are used to seal damaged metal and plastic pipes. They also enable repairs to be carried out easily, quickly and safely without the need to dismantle the pipes.

Advantages at a glance

- ✔ Ensures a reliable, safe, leakage-free seal of pipe damages
- ✔ Enables easy, quick and safe repair without dismantling the pipes
- ✔ Easy to install without special tools

Information

- Sizes: from 35.0 mm to 1219.1 mm
- Working pressure: from 60.0 bar to 4.0 bar
- Material: AISI 316 Ti
- EPDM:
 - Sizes from 35.0 mm up to 168.3 mm: -30 °C up to +125 °C
 - Sizes > 180.0 mm: -20 °C up to +80 °C
- NBR : from -20 °C up to +80 °C

Materials

W1	W2	W3	W4	W5
				x

Technical data & Ordering information

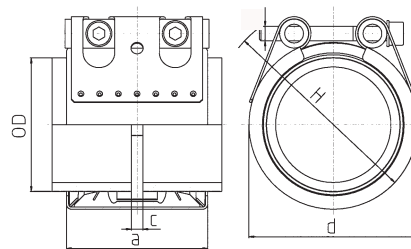

Technical data & Ordering information

NORMACONNECT® FGR REP E												
Ø (O.D.)	Designation	Clamping ranges	WP ¹	C max	Dimensions (approx.)			Weight (approx.)	Hex socket locking bolts		W5 Product No.	
		Odmin - Odmax (mm)	 [bar]	(mm)	a (mm)	d (mm)	H (mm)	(kg/pc.)	Thread	Tightening torque (Nm)	EPDM	NBR
35.0	Rep E W5 35.0	34.5 - 35.6	60	8	63	55	75	0.41	M 8 SW 6	5	0572 9360 035	0572 8660 035
38.0	Rep E W5 38.0	37.5 - 38.6	60	8	63	60	80	0.41	M 8 SW 6	5	0572 9360 038	0572 8660 038
42.4	Rep E W5 42.4	41.7 - 43.0	50	8	63	65	85	0.42	M 8 SW 6	5	0572 9360 042	0572 8660 042
44.5	Rep E W5 44.5	44.0 - 45.1	50	8	63	65	85	0.43	M 8 SW 6	5	0572 9360 044	0572 8660 044
48.3	Rep E W5 48.3	47.6 - 50.5	50	8	63	70	90	0.44	M 8 SW 6	5	0572 9360 048	0572 8660 048
54.0	Rep E W5 54.0	53.3 - 54.6	50	17	78	75	95	0.58	M 8 SW 6	10	0572 9360 054	0572 8660 054
57.0	Rep E W5 57.0	56.3 - 57.7	50	17	78	80	100	0.58	M 8 SW 6	10	0572 9360 057	0572 8660 057
60.3	Rep E W5 60.3	59.5 - 61.0	40	17	78	85	105	0.59	M 8 SW 6	10	0572 9360 060	0572 8660 060
70.0	Rep E W5 70.0	69.0 - 71.0	40	25	98	90	110	0.59	M 8 SW 6	10	0572 9360 070	0572 8660 070
73.0	Rep E W5 73.0	72.1 - 73.8	40	25	98	95	115	1.13	M 8 SW 6	10	0572 9360 073	0572 8660 073
76.1	Rep E W5 76.1	75.2 - 77.0	35	25	98	100	120	1.13	M 8 SW 6	10	0572 9360 076	0572 8660 076
78.0	Rep E W5 78.0	77.1 - 78.9	35	25	98	100	120	1.14	M 8 SW 6	15	0572 9360 078	0572 8660 078
80.0	Rep E W5 80.0	79.0 - 80.8	35	25	98	100	120	1.16	M 8 SW 6	15	0572 9360 080	0572 8660 080
84.0	Rep E W5 84.0	83.0 - 85.0	35	25	98	105	125	1.18	M 8 SW 6	15	0572 9360 084	0572 8660 084
88.9	Rep E W5 88.9	87.0 - 89.9	35	25	98	110	130	1.20	M 8 SW 6	15	0572 9360 088	0572 8660 088
101.6	Rep E W5 101.6	100.4 - 102.8	35	25	98	125	145	1.33	M 8 SW 6	15	0572 9360 101	0572 8660 101
104.0	Rep E W5 104.0	102.8 - 106.1	35	25	98	125	145	1.36	M 8 SW 6	15	0572 9360 104	0572 8660 104
108.0	Rep E W5 108.0	106.8 - 109.2	35	25	98	130	150	1.40	M 8 SW 6	15	0572 9360 108	0572 8660 108
110.0	Rep E W5 110.0	108.8 - 111.4	35	25	98	130	150	1.40	M 8 SW 6	20	0572 9360 110	0572 8660 110
114.3	Rep E W5 114.0	113.0 - 115.5	35	25	98	135	155	1.99	M 8 SW 6	30	0572 9360 114	0572 8660 114
129.0	Rep E W5 129.0	127.6 - 131.1	32	35	113	155	185	2.00	M 10 SW 8	30	0572 9360 129	0572 8660 129
133.0	Rep E W5 133.0	131.5 - 134.4	32	35	113	160	190	2.03	M 10 SW 8	30	0572 9360 133	0572 8660 133
139.7	Rep E W5 139.7	138.1 - 141.6	32	35	113	165	195	2.08	M 10 SW 8	30	0572 9360 139	0572 8660 139
141.3	Rep E W5 141.3	139.6 - 142.8	32	35	113	170	200	2.09	M 10 SW 8	35	0572 9360 141	0572 8660 141
154.0	Rep E W5 154.0	152.3 - 156.1	32	35	113	180	210	2.19	M 10 SW 8	50	0572 9360 154	0572 8660 154
159.0	Rep E W5 159.0	157.3 - 160.7	32	35	113	185	215	2.26	M 10 SW 8	50	0572 9360 159	0572 8660 159
168.3	Rep E W5 168.0	166.5 - 170.1	32	35	113	195	225	2.31	M 10 SW 8	50	0572 9360 168	0572 8660 168
180.0	Rep E W5 180.0	178.0 - 182.0	30.0	35	139	210	240	4.0	M 12 SW 10	25	0576 8360 180	0576 8660 180
193.7	Rep E W5 193.7	192.0 - 196.0	28.0	35	139	225	255	4.1	M 12 SW 10	25	0576 8360 193	0576 8660 193
206.0	Rep E W5 206.0	202.0 - 208.0	26.5	35	139	240	270	4.3	M 12 SW 10	25	0576 8360 206	0576 8660 206
219.0	Rep E W5 219.0	216.0 - 221.0	23.0	35	139	250	280	4.4	M 12 SW 10	25	0576 8360 219	0576 8660 219
225.0	Rep E W5 225.0	222.0 - 227.0	23.0	35	139	255	285	4.5	M 12 SW 10	25	0576 8360 225	0576 8660 225
229.9	Rep E W5 229.9	228.0 - 232.0	23.0	35	139	260	290	4.5	M 12 SW 10	25	0576 8360 229	0576 8660 229
244.5	Rep E W5 244.5	242.0 - 247.0	22.0	35	139	275	305	4.7	M 12 SW 10	25	0576 8360 244	0576 8660 244
254.0	Rep E W5 254.0	250.0 - 256.0	21.0	35	139	285	315	4.8	M 12 SW 10	25	0576 8360 254	0576 8660 254
267.0	Rep E W5 267.0	264.0 - 269.0	20.0	35	139	300	330	5.0	M 12 SW 10	25	0576 8360 267	0576 8660 267
273.0	Rep E W5 273.0	270.0 - 275.0	20.0	35	139	305	335	5.1	M 12 SW 10	25	0576 8360 273	0576 8660 273
306.0	Rep E W5 306.0	302.0 - 308.0	17.5	35	139	340	370	5.5	M 12 SW 10	25	0576 8360 306	0576 8660 306
323.9	Rep E W5 323.9	320.0 - 327.0	17.5	35	139	355	385	5.7	M 12 SW 10	25	0576 8360 323	0576 8660 323
326.0	Rep E W5 326.0	322.0 - 329.0	16.5	35	139	360	390	5.7	M 12 SW 10	25	0576 8360 326	0576 8660 326
355.6	Rep E W5 355.6	352.0 - 359.0	15.0	35	139	390	420	6.0	M 12 SW 10	25	0576 8360 355	0576 8660 355
406.4	Rep E W5 406.4	402.0 - 410.0	14.0	35	139	440	470	6.6	M 12 SW 10	25	0576 8360 406	0576 8660 406
429.0	Rep E W5 429.0	426.0 - 431.0	13.0	35	139	460	490	6.9	M 12 SW 10	40	0576 8360 429	0576 8660 429
442.0	Rep E W5 442.0	439.0 - 444.0	13.0	35	139	475	505	7.1	M 12 SW 10	40	0576 8360 442	0576 8660 442
457.2	Rep E W5 457.2	454.0 - 459.0	12.0	35	139	490	520	7.3	M 12 SW 10	40	0576 8360 457	0576 8660 457
508.0	Rep E W5 508.0	505.0 - 510.0	11.0	35	139	540	570	7.9	M 12 SW 10	40	0576 8360 508	0576 8660 508
531.0	Rep E W5 531.0	528.0 - 534.0	10.5	35	139	565	595	8.1	M 12 SW 10	40	0576 8360 531	0576 8660 531
558.8	Rep E W5 558.8	556.0 - 562.0	10.0	35	139	590	620	8.5	M 12 SW 10	40	0576 8360 558	0576 8660 558
609.6	Rep E W5 609.6	606.0 - 613.0	9.0	35	139	640	670	9.1	M 12 SW 10	40	0576 8360 609	0576 8660 609
634.0	Rep E W5 634.0	631.0 - 637.0	8.0	35	139	665	695	9.4	M 12 SW 10	40	0576 8360 634	0576 8660 634
711.2	Rep E W5 711.2	707.0 - 715.0	7.0	35	139	745	775	10.3	M 12 SW 10	40	0576 8360 711	0576 8668 711
762.0	Rep E W5 762.0	758.0 - 766.0	7.0	35	139	795	825	10.9	M 12 SW 10	40	0576 8360 762	0576 8668 762
812.8	Rep E W5 812.8	808.0 - 817.0	6.5	35	139	845	875	11.5	M 12 SW 10	40	0576 8368 812	0576 8668 812
914.4	Rep E W5 914.4	909.0 - 919.0	5.5	35	139	945	975	12.7	M 12 SW 10	45	0576 8368 914	0576 8668 914
1016.0	Rep E W5 1016.0	1013.0 - 1019.0	5.0	35	139	1050	1080	13.9	M 12 SW 10	45	0576 8368 016	0576 8668 016
1117.5	Rep E W5 1117.5	1114.0 - 1120.0	4.5	35	139	1150	1180	15.1	M 12 SW 10	50	0576 8368 117	0576 8668 117
1219.2	Rep E W5 1219.2	1216.0 - 1222.0	4.0	35	139	1250	1280	16.3	M 12 SW 10	50	0576 8368 219	0576 8668 219

Coupling sizes > 800 mm are in 2-parts design! Sizes > 1219.2 on request





NORMACONNECT® DCS – Infrastructure Connectors

The complete NORMACONNECT® DCS range has been proven a million times when used to achieve both a reliable and economic connection of socketless drainage pipes. Inside buildings, in underground car parks, buried in soil and for drainage systems in bridges, NORMACONNECT® DCS is the ideal connecting solution. A large number of well-known companies have been using our know-how in the development and manufacture of pipe connections for many years. Thus behind many successful brands enjoying a well established reputation you can find the certified quality and the reliability of NORMA® connections. Since the materials for our products are carefully chosen to match their applications and operating conditions, we can assure you that they function safely for a long time – as you would expect from a modern piping system.



Certificates, Liability, Memberships

Certificates

Materialprüfungsamt Nordrhein-Westfalen (MPA NRW)

Liability

Product liability: In case of bodily injury and/or material damage.

Memberships

IZEG – Informationszentrum Entwässerungstechnik Guss

GEG – Gütergemeinschaft Entwässerungstechnik Guss



Informationszentrum
Entwässerungstechnik Guss e.V.









Materials at a glance

Materials for connectors and claws				
	Collar	Clamping unit	Screws, Nuts, Bolts	Sealing sleeve
W1			Steel, protected surface	–
W2	AISI 430 Ti	AISI 304	Steel, protected surface	EPDM
W4	AISI 304	AISI 304	AISI 304	EPDM
W5	AISI 316 Ti	AISI 316 Ti	AISI 316	EPDM

Materials for NORMACONNECT pipe couplings				
	Collar	Clamping unit	Screws	Sealing sleeve
W2	AISI 304	Steel, protected surface	Steel, protected surface	EPDM
W5	AISI 316 Ti	AISI 316 Ti	AISI 316	EPDM

Products and Application at a glance

TYPE	DN and Pressure [bar]														Seal Type	Material	Application				
	40	50	70	75	75 S	75/80	100	125	150	200	250	300	400	500			600	Stand-ard	Build-ings	Bridges	Soil
NON-PULL-OUT resistant connections																					
RAPID 		•	•			•	•	•	•	•							EPDM	W 2	•	-	-
RAPID 		•	•			•	•	•	•	•	•						EPDM	W 5	•	•	•
MSM RAPID 		•	•			•	•	•	•	•							EPDM	W 2	•	-	-
Pull-out resistant connections																					
UNIVERSAL Claw * 		10	10			10	10	10	5	5	3	3					-	W 2	•	-	-
RECORD Claw * 		10	10			10	10	5	5	3							-	W 1	•	-	-
COMBI Claw * 		10	10			10	10	5	5	5	3	3					-	W 1	•	-	-
Changeover connectors																					
CONFIX 		•	•			•	•	•									EPDM	-	•	-	-

Technical Changes reserved

* The claws are only suitable for open drainage systems. It is not allowed for use in closed pressure systems.

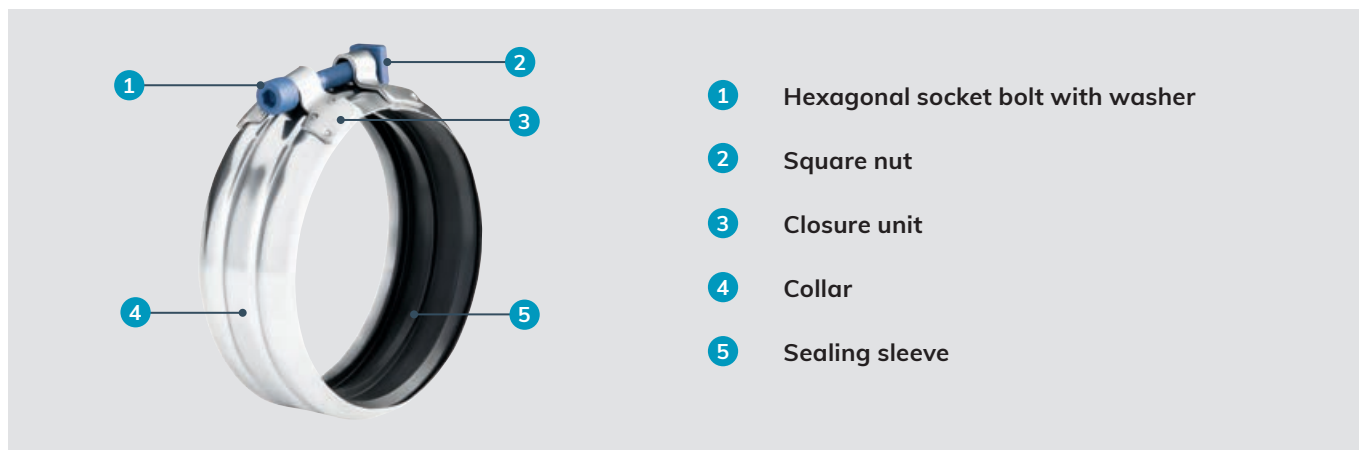

The original Rapid with block tightening

The NORMACONNECT® DCS RAPID with block tightening for non-pull-out resistant connections enables a fast connection. The visible torque control and the single-bolt closure provide for a fast and easy installation. Our DCS RAPID is the perfect solution to connect drainage fittings and pipes made of cast iron acc. to EN 877.

Materials

W1	W2	W3	W4	W5
	x			x

W2

- Material, Collar: AISI 430 Ti
- Material, Clamping unit: AISI 304 / AISI 430 Ti
- Material, Bolts/Nuts: Steel, surface protected
- Material, Sealing sleeve: EPDM

W5

- Material, Collar: AISI 316Ti
- Material, Clamping unit: AISI 316Ti
- Material, Bolts/Nuts, Steel, surface protected
- Material, Sealing sleeve: EPDM

Information

- DN 50 – DN 200: Resisting axial pull-out forces up to max. 0.5 bar
- DN 250 – DN 300: Resisting axial pull-out forces up to max. 0.3 bar
- Defined locking torque without using a special tool
- Meeting the fire protection requirements

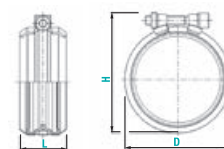

Technical data & Ordering information

NORMACONNECT® DCS RAPID									
Designation	Max. Dimensions after Assembly ~							W2 Product No.	W5 Product No.
	DN	D (mm)	H (mm)	L (mm)	P max (bar)	Torque (Nm)	Bolt (mm)		
RAPID DN 50	50	70	80	46	0.5	Tight-Locking	M 8	0245 8218 050	0245 8126 050
RAPID DN 70	70	90	100	43	0.5	Tight-Locking	M 8	0245 8219 070	0245 8127 070
RAPID DN 75 S	75	87	97	40.5	0.5	Tight-Locking	M 8	0245 8265 075	
RAPID DN 80	75/80	95	105	40	0.5	Tight-Locking	M 8	0245 8220 080	0245 8129 075
RAPID DN 100	100	125	135	39.0	0.5	Tight-Locking	M 8	0245 8221 100	0245 8130 100
RAPID DN 125	125	147	162	37.0	0.5	Tight-Locking	M 8	0245 8222 125	0245 8131 125
RAPID DN 150	150	172	187	35.5	0.5	Tight-Locking	M 8	0245 8223 150	0245 8132 150
RAPID DN 200	200	227	244	33.5	0.5	Tight-Locking	M 10	0245 8224 200	0245 8133 200
RAPID DN 250	250	293	306	96	0.3	Tight-Locking	M 10		0245 8208 250
RAPID DN 300	300	345	360	96	0.3	Tight-Locking	M 10		0245 8209 300



- 1 Hexagonal socket bolt with washer
- 2 Square nut
- 3 Closure unit
- 4 Collar
- 5 Sealing sleeve

The fast connection with quick release closure

The NORMACONNECT® DCS RAPID MSM connection is easy-fitting and thus especially suitable for repair purposes. It is the fast connection with quick release closure for non-pull-out resistant connections.



Materials

W1	W2	W3	W4	W5
	x			

W2

- Material, Collar: AISI 430 Ti
- Material, Clamping unit: AISI 304 / AISI 430 Ti
- Material, Bolts/Nuts: Steel, surface protected
- Material, Sealing sleeve: EPDM

Information

- Resisting axial pull-out forces up to max. 0.5 bar
- Defined locking torque without using a special tool
- Meeting the fire protection requirements

Technical data & Ordering information

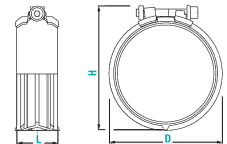

NORMACONNECT® DCS RAPID MSM								
Designation	Max. Dimensions after Assembly ~							W2 Product No.
	DN	D (mm)	H (mm)	L (mm)	P max (bar)	Torque (Nm)	Bolt (mm)	
RAPID DN 50 MSM	50	70	80	40	0.5	Tight-Locking	M 8	0245 8257 050
RAPID DN 70 MSM	70	90	100	40	0.5	Tight-Locking	M 8	0245 8258 070
RAPID DN 80 MSM	75/80	95	105	40	0.5	Tight-Locking	M 8	0245 8260 080
RAPID DN 100 MSM	100	125	135	46	0.5	Tight-Locking	M 8	0245 8261 100
RAPID DN 125 MSM	125	147	162	55	0.5	Tight-Locking	M 8	0245 8262 125
RAPID DN 150 MSM	150	172	187	55	0.5	Tight-Locking	M 8	0245 8263 150
RAPID DN 200 MSM	200	227	244	70	0.5	Tight-Locking	M 10	0245 8264 200



The powerful add-on claw

Combined with either DCS RAPID or DCS RAPID MSM standards connectors, our NORMACONNECT® DCS Universal Claw is an axial restraint claw which resists high tensile loads. The grip-type coupling resists high tensile loads for non-pull-out resistant connections.



Materials

W1	W2	W3	W4	W5
	x			

W2

- Material, Housing: AISI 430 Ti
- Material, Closure unit: Steel, surface protected
- Material, Grip ring: AISI 301

Information

Recommended for use in combination with types RAPID/ RAPID MSM: up to max. 10 bar

Technical data & Ordering information

NORMACONNECT® DCS Universal CLAW								
Designation	DN	A (mm)	D (mm)	H (mm)	Bolt (mm)	P max (bar)		W2 Product No.
						RAPID / RAPID MSM	Torque (Nm)	
Universal Claw DN 50	50	77	85	105	M 8	10	Tight-Locking	0262 8401 050
Universal Claw DN 70	70	77	100	120	M 8	10	Tight-Locking	0262 8402 070
Universal Claw DN 75S	75	77	100	120	M 8	10	Tight-Locking	0262 8404 075
Universal Claw DN 80	75/80	77	105	125	M 8	10	Tight-Locking	0262 8403 080
Universal Claw DN 100	100	97	130	150	M 10	10	Tight-Locking	0262 8405 100
Universal Claw DN 125	125	97	165	195	M 10	10	Tight-Locking	0262 8406 125
Universal Claw DN 150	150	97	185	215	M 10	5	Tight-Locking	0262 8407 150
Universal Claw DN 200	200	113	240	270	M 12	5	Tight-Locking	0262 8415 200
Universal Claw DN 250	250	139	305	335	M 12	3	Tight-Locking	0262 8416 250
Universal Claw DN 300	300	139	400	490	M 12	3	Tight-Locking	0262 8417 300

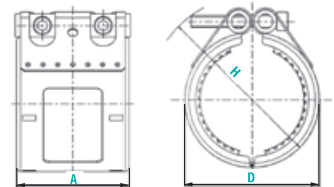

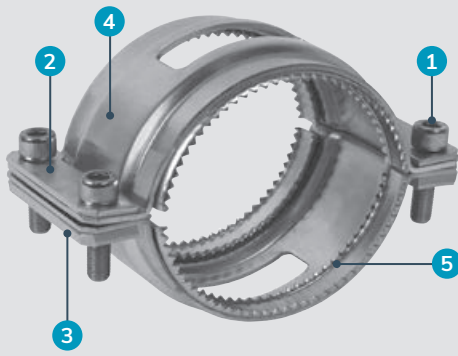

- 1 Hexagonal socket bolt with fine pitch thread
- 2 Guiding plate
- 3 Threaded plate
- 4 Housing
- 5 Grip ring insert (hardened)

The claw which resists high tensile loads

Axial restraint safety claw for use with pressurized pump lines in lifting systems as well as for rainwater sewage lines that are at risk of undergoing back pressures, but only in combination with the NORMACONNECT® DCS RAPID standard connectors. The powerful add-on claw for non-pull-out resistant connections.

Materials

W1	W2	W3	W4	W5
x				

W1

- Material, Housing: Steel, surface protected
- Material, Closure unit: Steel, surface protected

Advantages at a glance

- ✓ Two parts (halves) with hardened grip ring inserts
- ✓ Strong guiding plates with threaded holes plus four hexagonal socket bolts with fine pitch thread

Technical data & Ordering information

NORMACONNECT® DCS RECORD CLAW								
Designation	DN	A (mm)	D (mm)	L (mm)	Torque (Nm)	Bolt (mm)	P max (bar)	W1 Product No.
RECORD Claw DN 50	50	21	75	69	12-15	M 8	up to 10	0262 1265 050
RECORD Claw DN 70	70	21	95	69	12-15	M 8	up to 10	0262 1266 070
RECORD Claw DN 80	75/80	21	100	69	12-15	M 8	up to 10	0262 1287 080
RECORD Claw DN 100	100	25	135	87	25-30	M 10	up to 10	0262 1246 100
RECORD Claw DN 125	125	25	160	95	30-35	M 10	up to 5	0262 1267 125
RECORD Claw DN 150	150	25	185	95	30-35	M 10	up to 5	0262 1268 150
RECORD Claw DN 200	200	30	235	111	60-65	M 12	up to 3	0262 1269 200

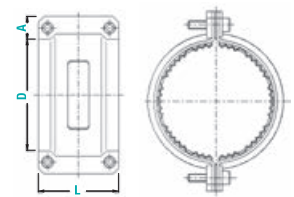

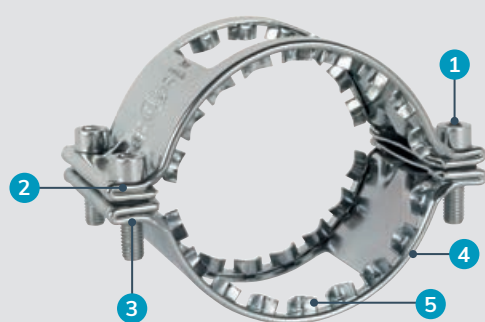

- 1 Hexagonal socket bolts
- 2 Guiding side
- 3 Threaded side
- 4 Housing
- 5 Anchoring teeth

The claw which resists high tensile loads

Our NORMACONNECT® DCS Combi Claw is an axial restraint safety claw for connecting rainwater and sewage lines that are at risk of undergoing back pressures. It is used in combination with NORMACONNECT® RAPID/RAPID MSM and standard connectors. The powerful add-on claw for non-pull-out resistant connections.

Materials

W1	W2	W3	W4	W5
x				

Information

- Axial restraint up to 10 bar
- Diameters DN 50 up to DN 300

W1

- Material, Housing: Steel, surface protected
- Material, Closure unit: Steel, surface protected

Technical data & Ordering information

NORMACONNECT® DCS COMBI CLAW								
Designation	DN	D (mm)	A (mm)	L (mm)	Torque (Nm)	Bolt (mm)	P max (bar)	W1 Product No.
COMBI Claw DN 50	50	76	18	72	20	M8	up to 10	0262 8590 050
COMBI Claw DN 80	80	99	18	72	20	M8	up to 10	0262 8590 080
COMBI Claw DN 100	100	130	21	82	25	M10	up to 10	0262 8591 100
COMBI Claw DN 125	125	156	21	96	25	M10	up to 8	0262 8592 125
COMBI Claw DN 150	150	180	21	96	25	M10	up to 8	0262 8592 150
COMBI Claw DN 200	200	235	27	110	65	M 12	up to 5	0262 8592 200
COMBI Claw DN 250	250	285	27	130	65	M 12	up to 3	0262 8592 250
COMBI Claw DN 300	300	335	27	130	65	M 12	up to 3	0262 8592 300

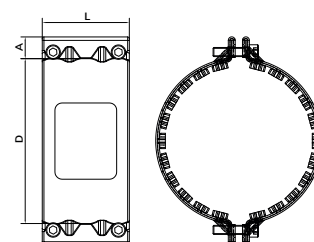



- 1 Easy handling
- 2 Strong worm-drive hose clamp

The changeover connector with 2 lip seals

The NORMACONNECT® CONFIX is a flexible connection which adapts to different pipe dimensions and materials.

Materials

W1	W2	W3	W4	W5
	x			

Material, Connector: EPDM
 Material, Worm-drive hose clamp band: AISI 430

Main advantage

- ✓ The connection of feed or suction lines to a pipe – either made of steel or plastics – is easily and safely achieved with the CONFIX connector.

Technical data & Ordering information

NORMACONNECT® DCS CONFIX, EPDM with TORRO W2, Changeover Connector											
Designation	DN	D1 (mm)	D3 (mm)	D4 (mm)	D5 (mm)	D7 (mm)	L1 (mm)	L3 (mm)	L8 (mm)	Insertion depth (mm)	W2 Product No.
CONFIX DN 50	50	72	56	30	67.5	57	63	19	19	42	0245 9003 050
CONFIX DN 70	70	92	75	41	86.5	77	77	19	24	55	0245 9003 070
CONFIX DN 80 56-75	80	92	75	41	91	81	77	19	24	55	0245 9003 075
CONFIX DN 80 75-90	80	108	90	58	93	81	88	19	23	60	0245 9003 080
CONFIX DN 100	100	128	110	78	118	108	95	21	23	65	0245 9003 100
CONFIX DN 125	125	145	126	90	145	132	103	26	27	75	0245 9003 125

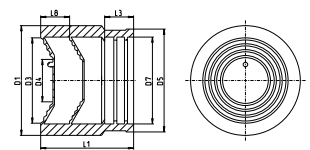

Dimensions of pipes and fittings to EN 877

Dimensions of pipes and fittings to EN 877				
DN	Outside Diameter (OD)		Wall Thickness	
	Nominal value	Tolerances	Nominal value	Minimum value
40	48	+2 -1	3.0	2.5
50	58	+2 -1	3.5	3.0
70	78	+2 -1	3.5	3.0
75/80	83	+2 -1	3.5	3.0
100	110	+2 -1	3.5	3.0
125	135	+2 -2	4.0	3.5
150	160	+2 -2	4.0	3.5
200	210	+2.5 -2.5	5.0	4.0
250	274	+2.5 -2.5	5.5	4.5
300	326	+2.5 -2.5	6.0	5.0
400	429	+2 -3	6.3	5.0
500	532	+2 -3.5	7.0	5.2
600	635	+2 -4	7.7	5.8

Dimensions in mm



COMPRESSION FITTINGS

NORMA CONNECT®

NORMA high-performance compression fittings

- ✓ Leakage-free connection for maximum water savings
- ✓ Excellent performance even under harsh conditions
- ✓ Highest durability for better system reliability

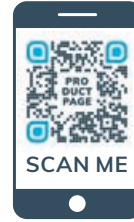

Find all details on our irrigation website:
norma-irrigation.com

NEW

QuickTight Technology
NORMA MARLIN®*



* Up to 50 % faster installations
Drinking water certified

Speed up your water pipe installations with QuickTight Technology!



NORMA MARLIN® PN 16

- Certified for drinking water
- Push fit installation in all sizes
- Faster and easier installation
- Lip-gasket technology for superior performance

More information:
norma-irrigation.com

Save time when repairing a broken pipe!



NORMA® Telescopic Fittings

- Ideal connection for repairing and taping into a PE pipe
- Dual O-rings are used to ensure leakage-free connections
- No additional components required for fixing the pipe
- Extensible telescopic function for easy and fast repair

More information:
norma-irrigation.com

High-performance compression fittings by NORMA



NORMA® PN 16

- Ideal for high-pressure applications
- Perfect water tightness
- Fast and easy connection
- Locking nut for clinching system

More information:
norma-irrigation.com

Cost-competitive high-quality compression fittings for your needs



NORMA® PN 10

- No special tooling required
- Easy connection
- High UV and temperature resistance
- Safe and durable

More information:
norma-irrigation.com



NORMACLAMP® – Hose Clamps

A comprehensive range to suit diverse applications

Whether you're looking for static hose clamps without springs or dynamic ones with springs, single-range or multi-range clamps, with NORMACLAMP® you'll find the perfect solution for any application.



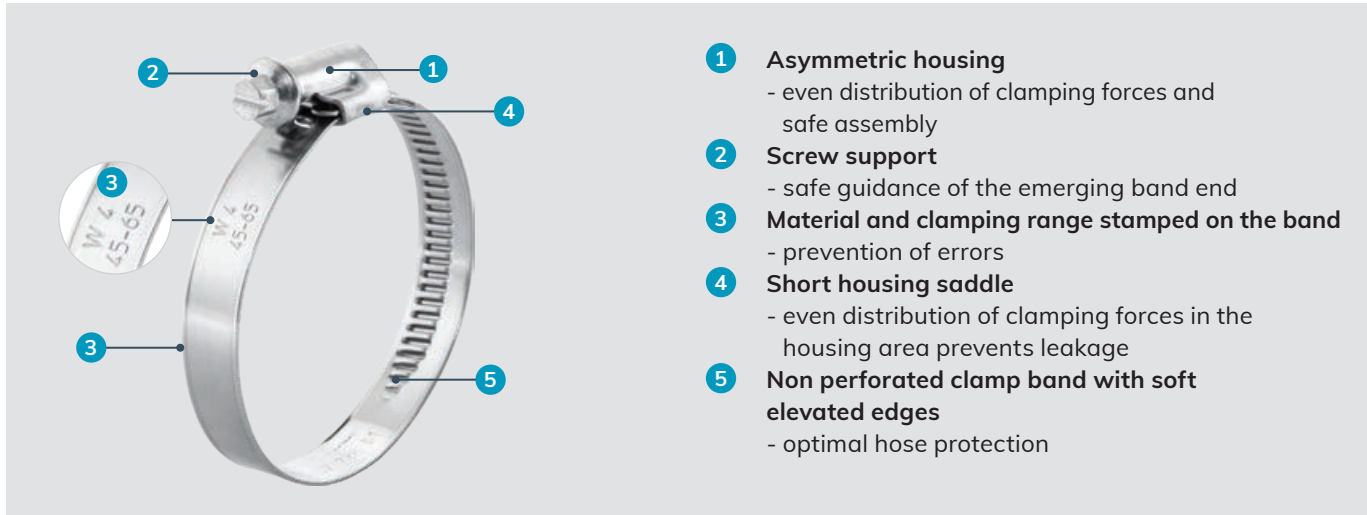

- 1 Asymmetric housing**
- even distribution of clamping forces and safe assembly
- 2 Screw support**
- safe guidance of the emerging band end
- 3 Material and clamping range stamped on the band**
- prevention of errors
- 4 Short housing saddle**
- even distribution of clamping forces in the housing area prevents leakage
- 5 Non perforated clamp band with soft elevated edges**
- optimal hose protection

Worm drive hose clamps in accordance with DIN 3017

NORMACLAMP® TORRO® multi-range hose clamps are ideally suited to applications with high mechanical loads. Thanks to the continuous developments these products have undergone, they remain the benchmark within modern clamp construction. Within the NORMACLAMP® range, only the TORRO® has its trademark asymmetrical construction. The asymmetric housing provides high force, superior torque and even distribution of clamping forces. Clamp aligns perfectly on the hose and ensures the optimal sealing of the connection.



Advantages at a glance

- ✓ Multi-range hose clamp
- ✓ No chromium (VI) used for coating purposes
- ✓ Clamping ranges in acc. with DIN 3017: 8-12 mm to 140-160 mm
- ✓ Larger diameters available on request

Applications

- Joining cooling water lines
- Depressurized and pressurized fuel lines and ventilation systems
- Oil lines
- Joining lines in sanitary applications
- Joining lines in machine building applications
- Lines in the household appliance industry
- Hose lines in the commercial vehicle industries

Materials

W1*	W2	W3	W4	W5
x	x	x	x	x

* No chromium (VI) used for the coating on the closure components

Material	Corrosion resistance in salt spray testing
W1	Min. 144 h
W2	Min. 72 h
W3	Min. 240 h*
W4	Min. 480 h
W5	Min. 1000 h

* Max 10% base metal corrosion permissible

Types of clamp band and screw

		W1	W2	W3	W4	W5
Phillips head	SW 7*	•	•			
Slotted head	SW 7			•	•	•

* Band width 7.5 mm = SW 6

Band width 7.5 mm

- W2, W3 with smooth inside

Band width 9 mm

- W1 with smooth inside
- W2, W3, W4, W5 with stamped inside

Band width 12 mm

- W1, W2, W3 with smooth inside
- W4, W5 with stamped inside

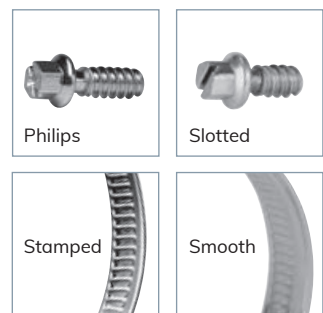

Technical data & Ordering information

NORMACLAMP® TORRO®													
Width	Designation	Clamping ranges		B	h	L	s	s (W1 only)	W1 Product No.	W2 Product No.	W4 Product No.	W5 Product No.	
		in mm	in inches										
7.5	TORRO 8-12/7.5	8-12	5/16-1/2"	11.5	9	17	0.6			0116 7602 010			
	TORRO 10-16/7.5	10-16	3/8-5/8"	11.5	9	17	0.6			0116 7602 013			
	TORRO 12-18/7.5	12-18	1/2-11/16"	11.5	9	17	0.6			0116 7602 015			
	TORRO 12-22/7.5	12-22	1/2-7/8"	11.5	9	17	0.6			0116 7602 017			
	TORRO 16-27/7.5	16-27	5/8-1 1/16"	11.5	9	17	0.6			0116 7602 021			
9	TORRO 8-12/9	8-12	5/16-1/2"	13.0	11.0	21.0	0.65	0.8	0126 7565 010	0126 7702 010	0126 7704 010		
	TORRO 8-16/9	8-16	5/16-5/8"	13.0	11.0	21.0	0.65	0.8		0126 7702 013	0126 7704 013	0126 7705 013	
	TORRO 10-16/9	10-16	5/16-5/8"	13.0	11.0	21.0	0.65	0.8	0126 7565 013				
	TORRO 12-22/9	12-22	1/2-7/8"	13.0	11.0	24.0	0.65	0.8	0126 7565 017	0126 7702 017	0126 7704 017	0126 7705 017	
	TORRO 16-27/9	16-27	5/8-1 1/16"	13.0	11.0	24.0	0.65	0.8	0126 7565 021	0126 7702 021	0126 7704 021	0126 7705 021	
	TORRO 20-32/9	20-32	13/16-1 1/4"	13.0	11.0	24.0	0.65	0.8	0126 7565 026	0126 7702 026	0126 7704 026	0126 7705 026	
	TORRO 25-40/9	25-40	1-1 9/16"	13.0	11.0	26.0	0.65	0.8	0126 7565 032	0126 7702 032	0126 7704 032	0126 7705 032	
	TORRO 30-45/9	30-45	1 3/16-1 3/4"	13.0	11.0	26.0	0.65	0.8	0126 7565 037	0126 7702 037	0126 7704 037	0126 7705 037	
	TORRO 35-50/9 (32-50)	35-50	1 3/8-2"	13.0	11.0	26.0	0.65	0.8	0126 7565 043	0126 7702 041	0126 7704 041	0126 7705 041	
	TORRO 40-60/9	40-60	1 9/16-2 3/8"	13.0	11.0	26.0	0.65	0.8	0126 7565 050	0126 7702 050	0126 7704 050	0126 7705 050	
	TORRO 50-70/9	50-70	2-2 3/4"	13.0	11.0	26.0	0.65	0.8	0126 7565 060	0126 7702 060	0126 7704 060	0126 7705 060	
	TORRO 60-80/9	60-80	2 3/8-3 1/8"	13.0	11.0	26.0	0.65	0.8	0126 7565 070	0126 7702 070	0126 7704 070	0126 7705 070	
	TORRO 70-90/9	70-90	2 3/4-3 9/16"	13.0	11.0	26.0	0.65	0.8	0126 7565 080	0126 7702 080	0126 7704 080	0126 7705 080	
	TORRO 80-100/9	80-100	3 1/8-3 15/16"	13.0	11.0	26.0	0.65	0.8	0126 7565 090	0126 7702 090	0126 7704 090	0126 7705 090	
	TORRO 90-110/9	90-110	3 9/16-4 5/16"	13.0	11.0	26.0	0.65	0.8	0126 7565 100	0126 7702 100	0126 7704 100	0126 7705 100	
	TORRO 100-120/9	100-120	3 15/16-4 3/4"	13.0	11.0	26.0	0.65	0.8	0126 6565 110	0126 6702 110	0126 6704 110	0126 6705 110	
	TORRO 110-130/9	110-130	4 5/16-5 1/8"	13.0	11.0	26.0	0.65	0.8	0126 6565 120	0126 6702 120	0126 6704 120	0126 6705 120	
	TORRO 120-140/9	120-140	4 3/4-5 1/2"	13.0	11.0	26.0	0.65	0.8	0126 6565 130	0126 6702 130	0126 6704 130	0126 6705 130	
	TORRO 130-150/9	130-150	5 1/8-5 15/16"	13.0	11.0	26.0	0.65	0.8	0126 6565 140	0126 6702 140	0126 6704 140	0126 6705 140	
	TORRO 140-160/9	140-160	5 1/2-6 5/16"	13.0	11.0	26.0	0.65	0.8	0126 6565 150	0126 6702 150	0126 6704 150	0126 6705 150	
	TORRO 150-170/9	150-170	5 7/8-6 3/4"	13.0	11.0	26.0	0.65	0.8	0126 6565 160	0126 6702 160	0126 6704 160	0126 6705 160	
	TORRO 160-180/9	160-180	6 1/4-7 1/16"	13.0	11.0	26.0	0.65	0.8	0126 6565 170	0126 6702 170	012 66704 170	0126 6705 170	
	TORRO 170-190/9	170-190	6 3/4-7 1/2"	13.0	11.0	26.0	0.65	0.8	0126 6565 180	0126 6702 180	012 66704 180	0126 6705 180	
	TORRO 180-200/9	180-200	7 1/16-7 7/8"	13.0	11.0	26.0	0.65	0.8	0126 6565 190	0126 6702 190	0126 6704 190	0126 6705 190	
	TORRO 190-210/9	190-210	7 1/2-8 1/4"	13.0	11.0	26.0	0.65	0.8	0126 6565 200	0126 6702 200	0126 6704 200	0126 6705 200	
	12	TORRO 16-27/12	16-27	5/8-1 1/16"	14.6	12.5	30.0	0.8	0.8	0136 7352 021	0136 7702 021	0136 7704 021	0136 7705 021
		TORRO 20-32/12	20-32	13/16-1 1/4"	14.6	12.5	30.0	0.8	0.8	0136 7352 026	0136 7702 026	0136 7704 026	0136 7705 026
		TORRO 25-40/12	25-40	1-1 9/16"	14.6	12.5	30.0	0.8	1.0	0136 7352 032	0136 7702 032	0136 7704 032	0136 7705 032
TORRO 30-45/12		30-45	1 3/16-1 3/4"	14.6	12.5	30.0	0.8	1.0	0136 7352 037	0136 7702 037	0136 7704 037	0136 7705 037	
TORRO 35-50/12		35-50	1 3/8-2"	14.6	12.5	30.0	0.8	1.0	0136 7352 043	0136 7702 043	0136 7704 043	0136 7705 043	
TORRO 40-60/12		40-60	1 9/16-2 3/8"	14.6	12.5	30.0	0.8	1.0	0136 7352 050	0136 7702 050	0136 7704 050	0136 7705 050	
TORRO 50-70/12		50-70	2-2 3/4"	14.6	12.5	30.0	0.8	1.0	0136 7352 060	0136 7702 060	0136 7704 060	0136 7705 060	
TORRO 60-80/12		60-80	2 3/8-3 1/8"	14.6	12.5	30.0	0.8	1.0	0136 7352 070	0136 7702 070	0136 7704 070	0136 7705 070	
TORRO 70-90/12		70-90	2 3/4-3 9/16"	14.6	12.5	36.0	0.8	1.0	0136 7352 080	0136 7702 080	0136 7704 080	0136 7705 080	
TORRO 80-100/12		80-100	3 1/8-3 15/16"	14.6	12.5	36.0	0.8	1.0	0136 7352 090	0136 7702 090	0136 7704 090	0136 7705 090	
TORRO 90-110/12		90-110	3 9/16-4 5/16"	14.6	12.5	36.0	0.8	1.0	0136 7352 100	0136 7702 100	0136 7704 100	0136 7705 100	
TORRO 100-120/12		100-120	3 15/16-4 3/4"	14.6	12.5	36.0	0.8	1.0	0136 6352 110	0136 6702 110	0136 6704 110	0136 6705 110	
TORRO 110-130/12		110-130	4 5/16-5 1/8"	14.6	12.5	36.0	0.8	1.0	0136 6352 120	0136 6702 120	0136 6704 120	0136 6705 120	
TORRO 120-140/12		120-140	4 3/4-5 1/2"	14.6	12.5	36.0	0.8	1.0	0136 6352 130	0136 6702 130	0136 6704 130	0136 6705 130	
TORRO 130-150/12		130-150	5 1/8-5 15/16"	14.6	12.5	36.0	0.8	1.0	0136 6352 140	0136 6702 140	0136 6704 140	0136 6705 140	
TORRO 140-160/12		140-160	5 1/2-6 5/16"	14.6	12.5	36.0	0.8	1.0	0136 6352 150	0136 6702 150	0136 6704 150	0136 6705 150	
TORRO 150-170/12		150-170	5 7/8-6 3/4"	14.5	12.5	36.0	0.8	1.0	0136 6352 160	0136 6702 160	0136 6704 160	0136 6705 160	
TORRO 160-180/12		160-180	6 1/4-7 1/16"	14.5	12.5	36.0	0.8	1.0	0136 6352 170	0136 6702 170	0136 6704 170	0136 6705 170	
TORRO 170-190/12		170-190	6 3/4-7 1/2"	14.5	12.5	36.0	0.8	1.0	0136 6352 180	0136 6702 180	0136 6704 180	0136 6705 180	
TORRO 180-200/12		180-200	7 1/16-7 7/8"	14.5	12.5	36.0	0.8	1.0	0136 6352 190	0136 6702 190	0136 6704 190	0136 6705 190	
TORRO 190-210/12		190-210	7 1/2-8 1/4"	14.5	12.5	36.0	0.8	1.0	0136 6352 200	0136 6702 200	0136 6704 200	0136 6705 200	
TORRO 200-220/12		200-220	7 7/8-8 5/8"	14.5	12.5	36.0	0.8	1.0	0136 6352 210	0136 6702 210	0136 6704 210	0136 6705 210	
TORRO 210-230/12		210-230	8 1/4-9 1/16"	14.5	12.5	36.0	0.8	1.0	0136 6352 220	0136 6702 220	0136 6704 220	0136 6705 220	
TORRO 220-240/12		220-240	8 5/8-9 1/2"	14.5	12.5	36.0	0.8	1.0	0136 6352 230	0136 6702 230	0136 6704 230	0136 6705 230	
TORRO 230-250/12		230-250	9 1/16-9 7/8"	14.5	12.5	36.0	0.8	1.0	0136 6352 240	0136 6702 240	0136 6704 240	0136 6705 240	
TORRO 240-260/12		240-260	9 1/2-10 1/4"	14.5	12.5	36.0	0.8	1.0	0136 6352 250	0136 6702 250	0136 6704 250	0136 6705 250	
TORRO 250-270/12		250-270	9 7/8-10 5/8"	14.5	12.5	36.0	0.8	1.0	0136 6352 260	0136 6702 260	0136 6704 260	0136 6705 260	
TORRO 260-280/12		260-280	10 1/4-11"	14.5	12.5	36.0	0.8	1.0	0136 6352 270	0136 6702 270	0136 6704 270	0136 6705 270	
TORRO 270-290/12	270-290	10 5/8-11 3/8"	14.5	12.5	36.0	0.8	1.0	0136 6352 280	0136 6702 280	0136 6704 280	0136 6705 280		
TORRO 280-300/12	280-300	11-11 7/8"	14.5	12.5	36.0	0.8	1.0	0136 6352 290	0136 6702 290	0136 6704 290	0136 6705 290		

Additional diameters on request (up to 700 mm).
Our recommendation for bigger diameters:
Available in W3 on request.

Refer to page 73

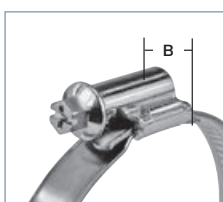

B = overall width housing

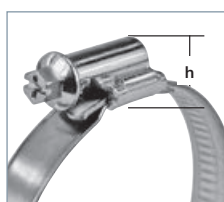

h = overall height bolt and housing

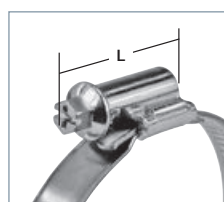

L = overall length bolt and housing

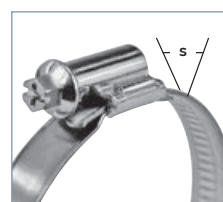

s = band thickness clamp band

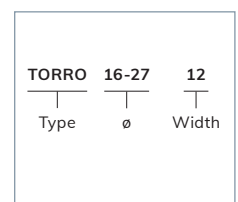

Name structure clamp band

NORMACLAMP®

Table of torques

NORMACLAMP® TORRO®				
Band width (mm)	Material	Diameters	TT	FRT
7.5	W2, W3	all diameters	1.5	-
9	W1	8-12 mm	2.5+0.5	1.2
		all other diameters	3+0.5	1.2
	W2	10-16 mm	2+0.5	0.7
		all other diameters	3+0.5	0.7
	W3, W4, W5	10-16 mm	2+0.5	0.7
		all other diameters	3+0.5	0.7
12	W1	all diameters	5+0.5	1.2
	W2, W3	all diameters	5+0.5	1
	W4, W5	all diameters	5+0.5	1

TT = Tightening Torque
 FRT = Free Running Torque

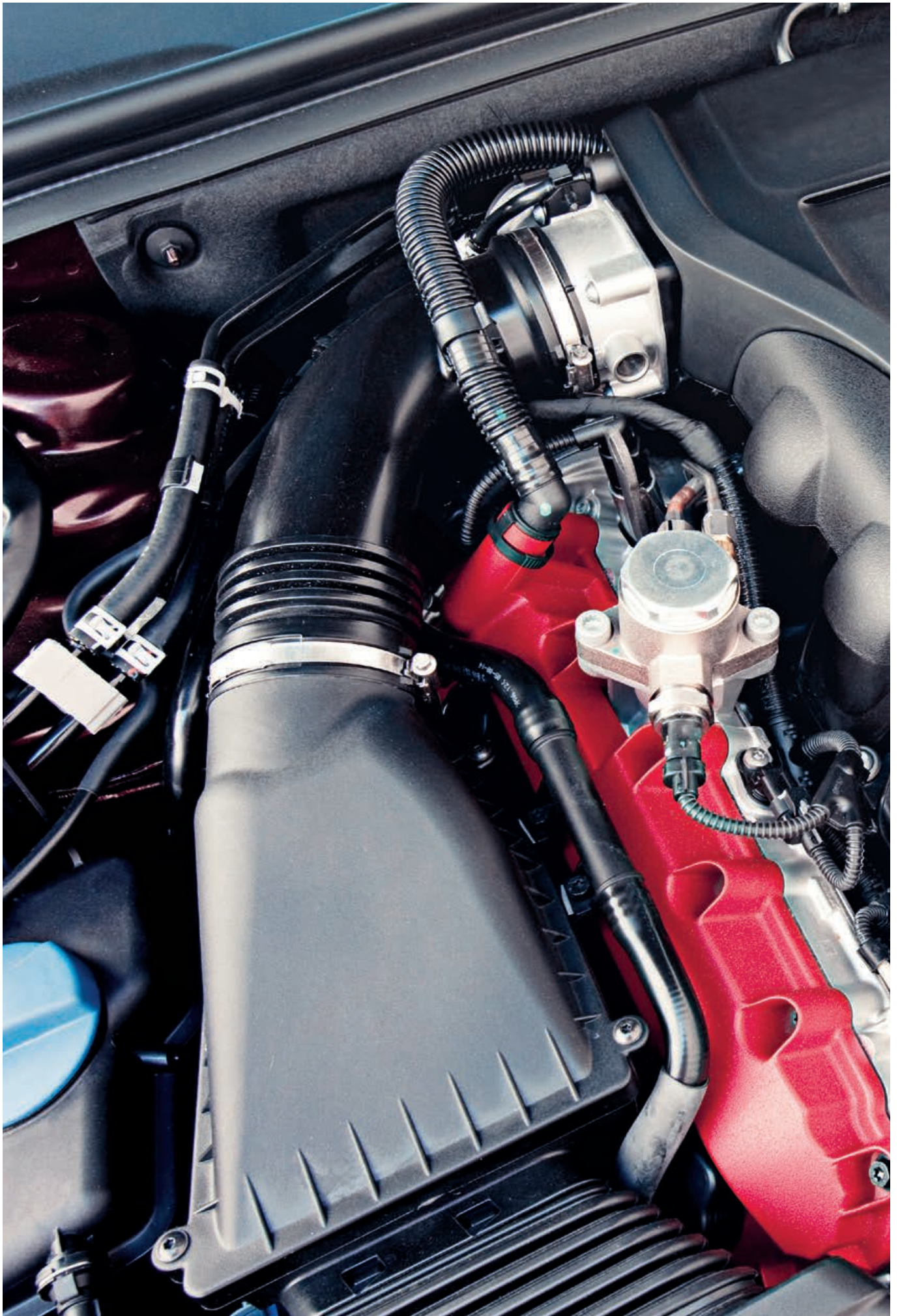

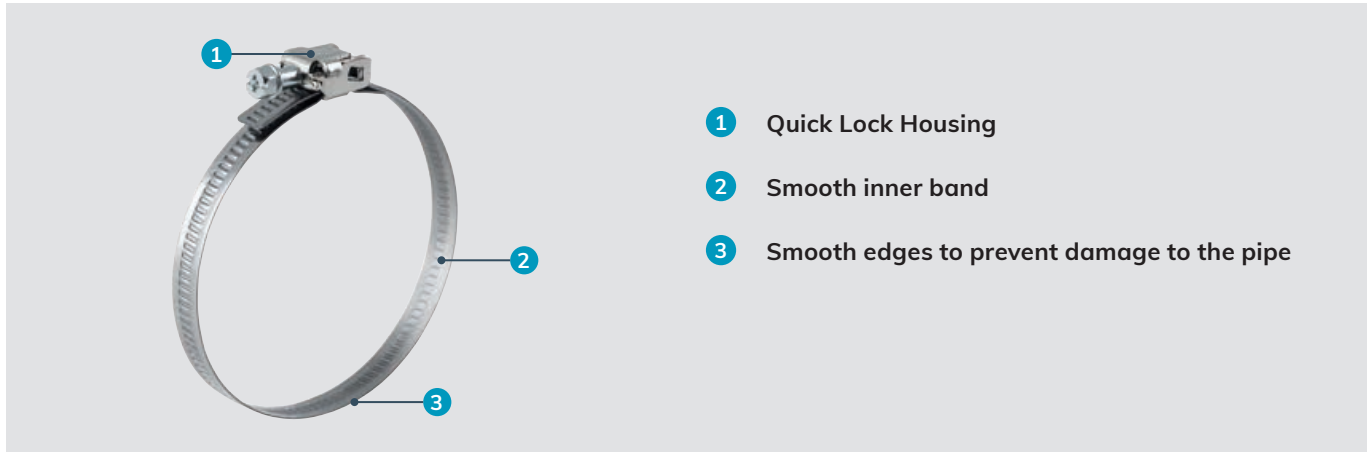

- 1 Quick Lock Housing
- 2 Smooth inner band
- 3 Smooth edges to prevent damage to the pipe

Quick locking clamp

NORMACLAMP® Quick Lock 9 mm is manufactured from a continuously threaded band with smooth edges to prevent damage to the pipe. The Quick Lock housing allows easy

and quick application, as the band can be adjusted to the right diameter of the pipe, before securing the lock with the screw. Band thickness 0.6 mm for band width 9 mm.

Advantages at a glance

- ✓ Easy and quick application
- ✓ Safe joint with the hose
- ✓ Flexibility
- ✓ Clamping range from 25-40 up to 60-1300 mm

Applications

- Water industry
- Air conditioning
- Construction
- Sanitary

Materials

W1	W2 (B)*	W3	W4	W5
	x		x	

* W2 (B): Band in stainless steel (W3)
Screw and housing in galvanized steel (W1)
W2 (B) is a combination of W1 and W3 materials

Torques

Band width	Tightening torque	Tightening speed
9	2.5+0.5 Nm	Max. 50 RPM

Technical data & Ordering information

NORMACLAMP® QUICK LOCK 9 MM					
Width	Designation	Clamping ranges		W2 (B) Product No.	W4 Product No.
		in mm	in inches		
9	QUICK LOCK 25-45/9	25-45	1-1 3/4"	0815 6120 045	
	QUICK LOCK 40-60/9	40-60	1 9/16-2 3/8"	0815 6120 060	
	QUICK LOCK 60-90/9	60-90	2 3/8-3 9/16"	0815 6120 090	
	QUICK LOCK 60-110/9	60-110	2 3/8-4 5/16"	0815 6120 110	0815 6130 110
	QUICK LOCK 60-135/9	60-135	2 3/8-5 5/16"	0815 6120 135	0815 6130 135
	QUICK LOCK 60-145/9	60-145	2 3/8-5 11/16"	0815 6120 145	0815 6130 145
	QUICK LOCK 60-170/9	60-170	2 3/8-6 11/16"		0815 6130 170
	QUICK LOCK 60-175/9	60-175	2 3/8-6 7/8"	0815 6120 175	
	QUICK LOCK 60-215/9	60-215	2 3/8-8 7/16"	0815 6120 215	0815 6130 215
	QUICK LOCK 60-270/9	60-270	2 3/8-10 5/8"	0815 6120 270	0815 6130 270
	QUICK LOCK 60-325/9	60-325	2 3/8-12 13/16"	0815 6120 325	0815 6130 325
	QUICK LOCK 60-380/9	60-380	2 3/8- 14 15/16"	0815 6120 380	0815 6130 380
	QUICK LOCK 60-425/9	60-425	2 3/8-16 3/4"	0815 6120 425	0815 6130 425
	QUICK LOCK 60-525/9	60-525	2 3/8-20 11/16"	0815 6120 525	0815 6130 525
	QUICK LOCK 60-660/9	60-660	2 3/8-26"	0815 6120 660	0815 6130 660

Additional diameters available on request



Refer to page 72

NORMACLAMP®

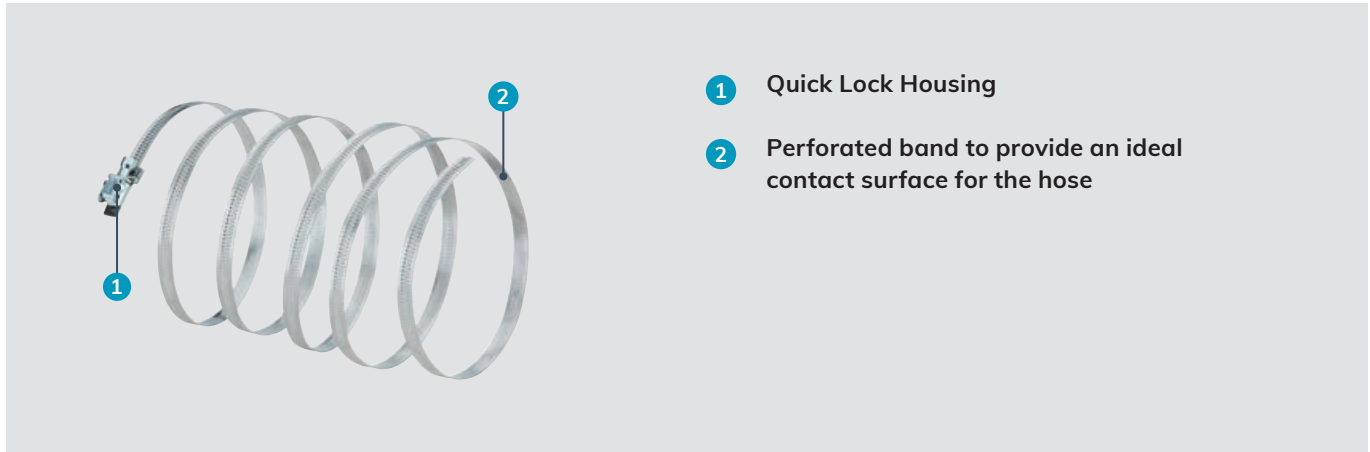

- 1 Quick Lock Housing
- 2 Perforated band to provide an ideal contact surface for the hose

The clamp for large hoses

NORMACLAMP® Quick Lock 12 mm is designed for quick-lock tightening and releasing of large diameter hoses and supplied in a perforated band, to provide an ideal contact surface for the hose. This clamp is the ideal solution for larger hose diameters over 100 mm. Band thickness 0.7 mm for band width 12 mm assures a very flexible clamp.

Advantages at a glance

- ✓ The quick-lock housing eases the assembly of the clamp
- ✓ Safe joint with the hose
- ✓ Flexibility
- ✓ Wide clamping range

Applications

- Water industry
- Air conditioning
- Construction
- Sanitary

Materials

W1	W2 (B)*	W3	W4	W5
	x			

* W2 (B): Band in stainless steel (W3)
Screw and housing in galvanized steel (W1)
W2 (B) is a combination of W1 and W3 materials

Technical data & Ordering information

NORMACLAMP® QUICK LOCK 12 MM				
Width	Designation	Clamping ranges		W2 (B) Product No.
		in mm	in inches	
12	QUICK LOCK 50-110/12	50-110	2-4 5/16"	0815 6020 080
	QUICK LOCK 50-130/12	50-130	2-5 1/8"	0815 6020 090
	QUICK LOCK 50-145/12	50-145	2-5 11/16"	0815 6020 098
	QUICK LOCK 50-165/12	50-165	2-6 1/2"	0815 6020 108
	QUICK LOCK 50-175/12	50-175	2-6 7/8"	0815 6020 113
	QUICK LOCK 50-215/12	50-215	2-8 7/16"	0815 6020 133
	QUICK LOCK 50-280/12	50-280	2-11"	0815 6020 165
	QUICK LOCK 50-325/12	50-325	2-12 13/16"	0815 6020 188
	QUICK LOCK 50-370/12	50-370	2-14 9/16"	0815 6020 210
	QUICK LOCK 50-425/12	50-425	2-16 3/4"	0815 6020 238
	QUICK LOCK 60-525/12	60-525	2-20 11/16"	0815 6020 293
	QUICK LOCK 70-625/12	70-625	2-24 5/8"	0815 6020 348



Refer to page 72

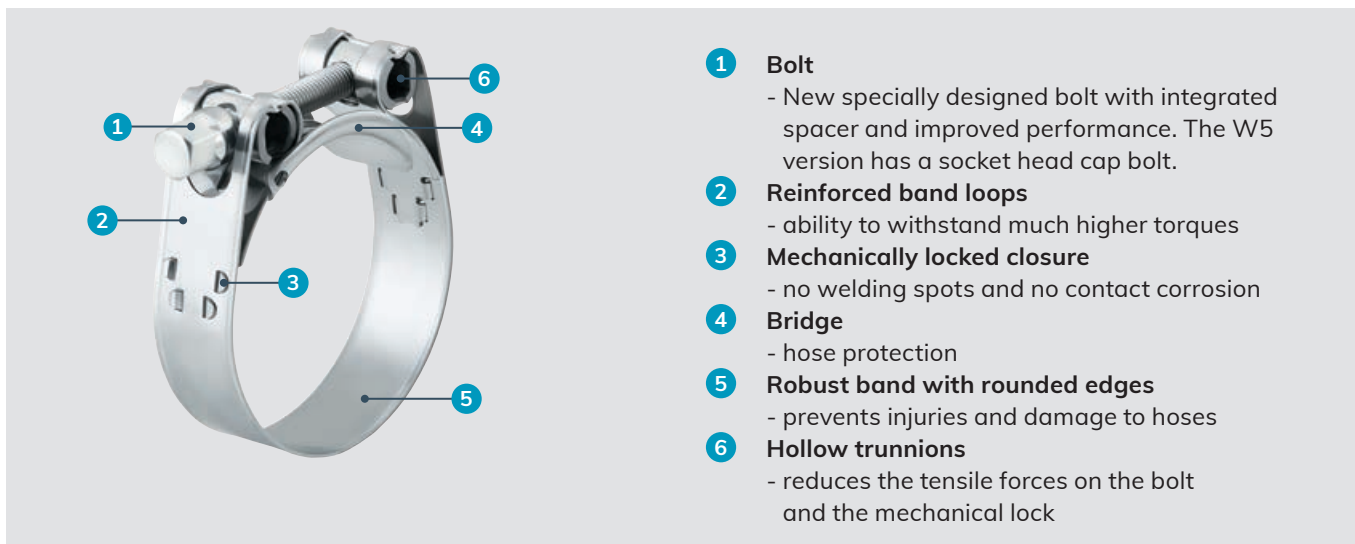

- 1 Bolt**
- New specially designed bolt with integrated spacer and improved performance. The W5 version has a socket head cap bolt.
- 2 Reinforced band loops**
- ability to withstand much higher torques
- 3 Mechanically locked closure**
- no welding spots and no contact corrosion
- 4 Bridge**
- hose protection
- 5 Robust band with rounded edges**
- prevents injuries and damage to hoses
- 6 Hollow trunnions**
- reduces the tensile forces on the bolt and the mechanical lock

NORMACLAMP®

Heavy-duty clamps for multiple applications

NORMACLAMP® GBS M is designed primarily for use in applications where hose clamps must meet stringent requirements. In particular if suction and pressure hoses – complete with plastic or steel inserts and high shore hardness values – are to be connected and attached. They are particularly suitable for use on commercial and special vehicles. NORMACLAMP® GBS M clamps' ability to withstand exceptionally high levels of band tensile force is an outstanding feature. They are also extremely easy to install, whether you're using manual, pneumatic or electrical standard tools.



Advantages at a glance

- ✓ Failure torques improved by a factor of two
- ✓ Band tensile force levels improved by a factor of three

Applications

- Machine building
- Chemical industry
- Irrigation systems
- Ship manufacturing
- Railway industry
- Agricultural machines
- Building machines
- Engine manufacturing
- Pump and filter
- Mining Industry

Materials

W1	W2	W3	W4	W5
x	x		x	x

Material	Corrosion resistance in salt spray testing
W1	Min. 72 h
W2	Min. 72 h
W4	Min. 240 h
W5	Min. 400 h

NORMACLAMP® GBS M						
Band width	Material thickness in mm					
	W1	W2	W4	W5	M	SW
18	0.8	0.6	0.6	0.6	6	8
20	1.0	0.8	0.8	0.8	7	10
25	1.0	1.0	1.0	1.0	8	13
30	1.3	1.0	1.0	1.0	10	17

Band tensile force

Numerous test results underline the technical superiority of NORMACLAMP® GBS M products over their competitors':

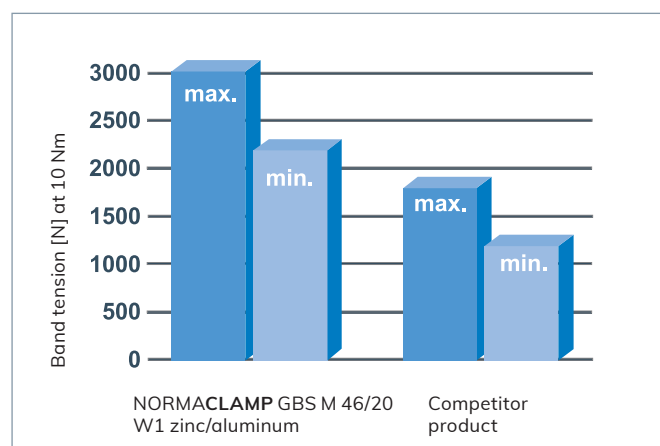

Table of torques

NORMACLAMP® GBS M					
Band width	Failure torque (minimum) Nm				Recommended tightening torque Nm
	W1	W2	W4	W5	
18	15	15	15	15	8
20	25	20	20	20	10
25	35	30	30	30	20
30	50	45	45	45	25

NORMACLAMP® GBS M RUBBER INSERT			
Band width	Failure torque (minimum) Nm		Recommended tightening torque Nm
	W1	W2	
18	10	10	6
20	15	15	8
25	25	25	18
30	40	40	22

Please note: the recommended tightening speed should not exceed 250 rpm

Technical data & Ordering information

NORMACLAMP® GBS M HOLLOW TRUNNION							
Width	Designation	Clamping ranges		W1 Product No.	W2 Product No.	W4 Product No.	W5** Product No.
		in mm	in inches				
18	GBS M 17-19/18 Sk*	17-19	11/16-3/4"	0591 7181 018	0591 7182 018	0591 7184 018	0591 7185 018
	GBS M 19-21/18 Sk*	19-21	3/4-13/16"	0591 7181 020	0591 7182 020	0591 7184 020	0591 7185 020
	GBS M 21-23/18 Sk*	21-23	13/16-15/16"	0591 7181 022	0591 7182 022	0591 7184 022	0591 7185 022
	GBS M 23-25/18 Sk*	23-25	15/16-1"	0591 7181 024	0591 7182 024	0591 7184 024	0591 7185 024
	GBS M 25-27/18 Sk	25-27	1-1 1/16"	0591 7181 026	0591 7182 026	0591 7184 026	0591 7185 026
	GBS M 27-29/18 Sk	27-29	1 1/16-1 1/8"	0591 7181 028	0591 7182 028	0591 7184 028	0591 7185 028
	GBS M 29-31/18 Sk	29-31	1 1/8-1 1/4"	0591 7181 030	0591 7182 030	0591 7184 030	0591 7185 030
	GBS M 31-34/18 Sk	31-34	1 1/4-1 5/16"	0591 7181 033	0591 7182 033	0591 7184 033	0591 7185 033
	GBS M 34-37/18 Sk	34-37	1 5/16-1 7/16"	0591 7181 036	0591 7182 036	0591 7184 036	0591 7185 036
	GBS M 37-40/18 Sk	37-40	1 7/16-1 9/16"	0591 7181 039	0591 7182 039	0591 7184 039	0591 7185 039
20	GBS M 40-43/18 Sk	40-43	1 9/16-1 11/16"	0591 7181 042	0591 7182 042	0591 7184 042	0591 7185 042
	GBS M 43-47/20 Sk	43-47	1 11/16-1 7/8"	0591 7201 045	0591 7202 045	0591 7204 045	0591 7205 045
	GBS M 47-51/20 Sk	47-51	1 7/8-2"	0591 7201 049	0591 7202 049	0591 7204 049	0591 7205 049
	GBS M 51-55/20 Sk	51-55	2-2 3/16"	0591 7201 053	0591 7202 053	0591 7204 053	0591 7205 053
	GBS M 55-59/20 Sk	55-59	2 3/16-2 5/16"	0591 7201 057	0591 7202 057	0591 7204 057	0591 7205 057
	GBS M 59-63/20 Sk	59-63	2 5/16-2 1/2"	0591 7201 061	0591 7202 061	0591 7204 061	0591 7205 061
	GBS M 63-68/20 Sk	63-68	2 1/2-2 11/16"	0591 7201 066	0591 7202 066	0591 7204 066	0591 7205 066
25	GBS M 68-73/25 Sk	68-73	2 11/16-2 7/8"	0591 7251 071	0591 7252 071	0591 7254 071	0591 7255 071
	GBS M 73-79/25 Sk	73-79	2 7/8-3 1/8"	0591 7251 076	0591 7252 076	0591 7254 076	0591 7255 076
	GBS M 79-85/25 Sk	79-85	3 1/8-3 3/8"	0591 7251 082	0591 7252 082	0591 7254 082	0591 7255 082
	GBS M 85-91/25 Sk	85-91	3 3/8-3 9/16"	0591 7251 088	0591 7252 088	0591 7254 088	0591 7255 088
	GBS M 91-97/25 Sk	91-97	3 9/16-3 13/16"	0591 7251 094	0591 7252 094	0591 7254 094	0591 7255 094
	GBS M 97-104/25 Sk	97-104	3 13/16-4 1/6"	0591 7251 101	0591 7252 101	0591 7254 101	0591 7255 101
	GBS M 104-112/25 Sk	104-112	4 1/16-4 7/16"	0591 7251 108	0591 7252 108	0591 7254 108	0591 7255 108
	GBS M 112-121/25 Sk	112-121	4 7/16-4 3/4"	0591 7251 117	0591 7252 117	0591 7254 117	0591 7255 117
30	GBS M 121-130/25 Sk	121-130	4 3/4-5 1/8"	0591 7251 126	0591 7252 126	0591 7254 126	0591 7255 126
	GBS M 130-140/30 Sk	130-140	5 1/8-5 1/2"	0591 7301 135	0591 7302 135	0591 7304 135	0591 7305 135
	GBS M 140-150/30 Sk	140-150	5 1/2-5 15/16"	0591 7301 145	0591 7302 145	0591 7304 145	0591 7305 145
	GBS M 150-162/30 Sk	150-162	5 15/16-6 3/8"	0591 7301 156	0591 7302 156	0591 7304 156	0591 7305 156
	GBS M 162-174/30 Sk	162-174	6 3/8-6 7/8"	0591 7301 168	0591 7302 168	0591 7304 168	0591 7305 168
	GBS M 174-187/30 Sk	174-187	6 7/8-7 3/8"	0591 7301 181	0591 7302 181	0591 7304 181	0591 7305 181
	GBS M 187-200/30 Sk	187-200	7 3/8-7 7/8"	0591 7301 194	0591 7302 194	0591 7304 194	0591 7305 194
	GBS M 200-213/30 Sk	200-213	7 7/8-8 3/8"	0591 7301 207	0591 7302 207	0591 7304 207	0591 7305 207
	GBS M 213-226/30 Sk	213-226	8 3/8-8 7/8"	0591 7301 220	0591 7302 220	0591 7304 220	0591 7305 220
	GBS M 226-239/30 Sk	226-239	8 7/8-9 7/16"	0591 7301 233	0591 7302 233	0591 7304 233	0591 7305 233
	GBS M 239-252/30 Sk	239-252	9 7/16-9 15/16"	0591 7301 246	0591 7302 246	0591 7304 246	0591 7305 246
	GBS M 252-265/30 Sk	252-265	9 15/16-10 7/16"	0591 7301 259	0591 7302 259	0591 7304 259	0591 7305 259
GBS M 265-278/30 Sk	265-278	10 7/16-10 15/16"	0591 7301 272	0591 7302 272	0591 7304 272	0591 7305 272	
GBS M 279-291/30 Sk	279-291	11-11 7/16"	0591 7301 285	0591 7302 285	0591 7304 285	0591 7305 285	
GBS M 292-304/30 Sk	292-304	11 1/2-12"	0591 7301 298	0591 7302 298	0591 7304 298	0591 7305 298	

* These diameters are full trunnions and do not feature a mechanically locked closure, they are spot-welded.

** ISK bolt for W5 material

NORMAFIX® – Retaining Products

Versatile products for a whole host of applications

The NORMAFIX® range of clamps, clips and systems for retaining pipes, cables, cable harnesses and hoses are ready for action wherever they're needed – walls, ceilings or car bodies.

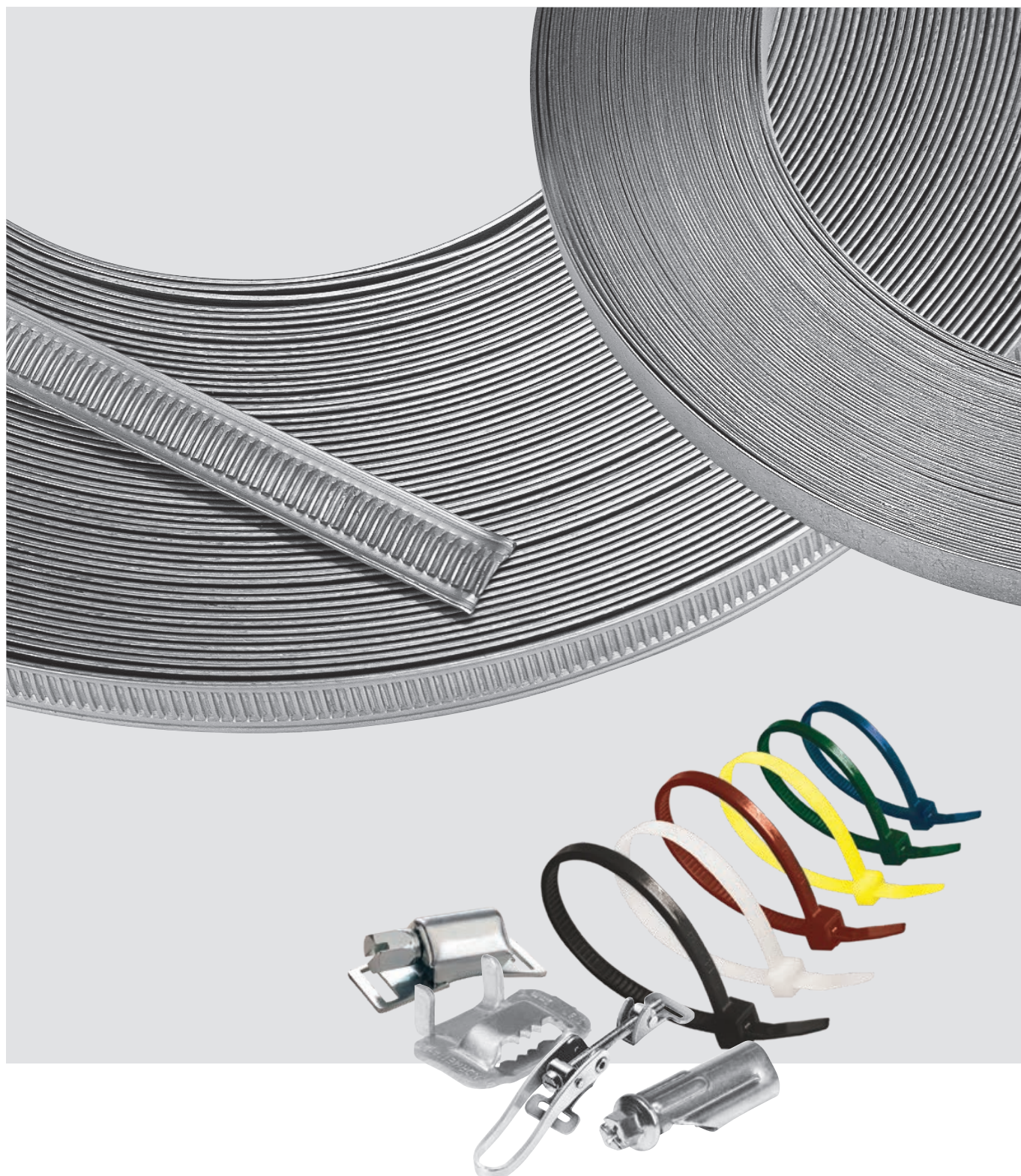

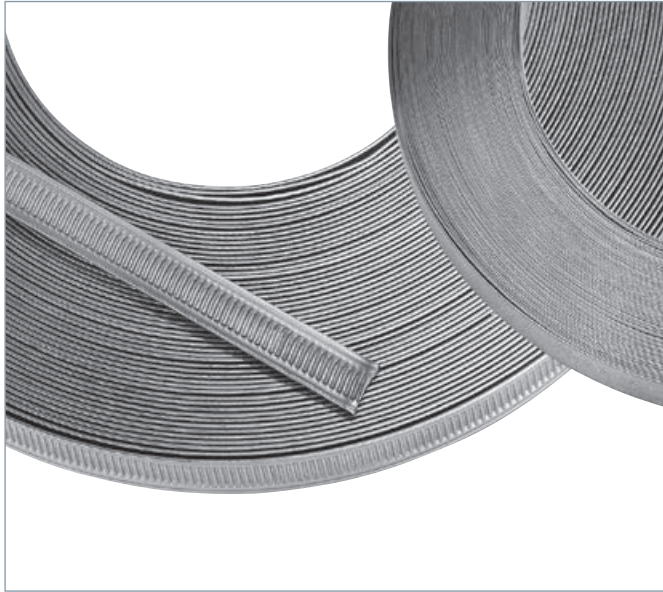

Continuous band available in smooth version or with thread stamping throughout

4 different closure types to suit a huge variety of applications



Continuous band clamping system

Consisting of a continuous band, the NORMAFIX® NORMETTA® system is able to adapt itself to the shape and size of various objects. 4 different types of closure are available to choose from. The system is particularly suitable for carrying out retaining and repair work under difficult and extreme conditions.

Advantages at a glance

- ✓ Flexible and versatile
- ✓ Can be installed under difficult conditions

Materials

W1	W2	W3	W4	W5
	x	x	x	

Applications

- Irrigation systems
- Railway industry
- Building machines
- Pump and filter
- Retaining applications; sealing pipes during repair work
- Attaching signs and containers
- Binding hoses



Product and closure types

The continuous band is available in three different versions: smooth band, stamped band or perforated band. Depending on the version, you will have a different choice of band widths, material grades and closure types.

Smooth band



To be used with the buckles, NB-D W4 and NB-H W4.

NORMAFIX® NORMETTA® SMOOTH BAND				
Width in mm	Thickness in mm	Designation	Length in m	W4 Product No.
9	0.5	NORMETTA SMOOTH BAND 30M/9 W4	30	0560 8554 009
13	0.7	NORMETTA SMOOTH BAND 30M/13 W4	30	0560 8553 013
16	0.7	NORMETTA SMOOTH BAND 30M/16 W4	30	0560 8553 016
19	0.7	NORMETTA SMOOTH BAND 30M/19 W4	30	0560 8553 019



Refer to page 72

Stamped band

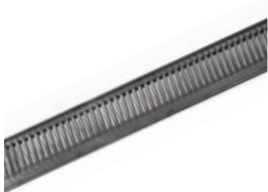

To be used with the buckles NB-G W3.

NORMAFIX® NORMETTA® STAMPED BAND					
Width in mm	Thickness in mm	Designation	Length in m	Resistance to traction in N	W3 Product No.
12	0.8	NORMETTA STAMPED BAND 30M/12 W3	30	2600 N	0560 8566 003

Perforated Band



To be used with buckles NB-K W2.

NORMAFIX® NORMETTA® PERFORATED BAND						
Width in mm	Thickness in mm	Designation	Length in m	Resistance to traction in N	W2 Product No.	W4 Product No.
8	0.6	NORMETTA PERFORATED BAND 25M/8 W2	25	790 N	0817 7020 001	
	0.6	NORMETTA PERFORATED BAND 25M/8 W4	25	790 N		0817 7022 001
13	0.6	NORMETTA PERFORATED BAND 25M/13 W4	25	850 N		0817 7022 002
14	0.6	NORMETTA PERFORATED BAND 25M/14 W2	25	850 N	0817 7020 002	

NB-D



Closure type NB-D

Suitable for attaching signs and containers to pipes and hoses as well as binding hoses.
For bands: 9, 13, 16, 19 mm

Required tools: Clamping and cutting tool; hammer

NORMAFIX® NB-D		
For band width in mm	Designation	W4 Product No.
9	NB-D/9	0560 8550 009
13	NB-D/13	0560 8550 013
16	NB-D/16	0560 8550 016
19	NB-D/19	0560 8550 019

NB-G



Closure type NB-G

Suitable for applications with cramped installation conditions.
Can be re-used.

For stamped bands.

Required tools: Screwdriver or SW7 socket wrench and plate shears

NORMAFIX® NB-G		
For band width in mm	Designation	W3 Product No.
12	NB-G/12	0560 8565 003

NB-H



Closure type NB-H

An adjustable quick-release closure that enables fast and easy installation and removal. Can be re-used.

For bands: 16, 19 mm

Required tools: Screwdriver and plate shears

NORMAFIX® NB-H			
For band width in mm	Maximum diameter in mm	Designation	W1 Product No.
16 / 19	124	NB-H/124	0560 8558 124
	400	NB-H/400	0560 8558 400
	800	NB-H/800	0560 8558 800

NB-K



Closure type NB-K

Suitable for fixing suspended ventilation tubes.

For bands: 8, 13, 14 mm

Required tools: Screwdriver

NORMAFIX® NB-K			
For band width in mm	Designation	W2 Product No.	W4 Product No.
8	NB-K/8	0817 7019 003	0817 7021 003
13	NB-K/13		0817 7021 004
14	NB-K/14	0817 7019 004	



Smooth round edges

- easier to handle and safer to install

Variety of colors

- available in: black, white, red, yellow, green, blue

“Carbon Black” added in black cable tie flange

- increased resistance to UV rays
- suitable for outdoor use

Quick and safe securing of cables in material PA 6.6

NORMAFIX® Cable Tie for securing cables in electrical installations, industrial wiring, automotive, etc. Made of polyamide 6.6. Resistant to extreme temperatures and numerous external agents. Quick and safe assembly. The black cable tie offers excellent resistance to UV rays thanks to added “carbon black.”



NORMAFIX®

Advantages at a glance

- ✓ Made of polyamide 6.6 for optimum resistance to extreme temperatures, bases, oils, greases, etc.
- ✓ Bent rounded tip allows easier insertion through the head of the cable ties
- ✓ Low-friction material coefficient allows a faster installation

Applications

- Electrical installations
- Industrial cabling
- Automotive cabling
- Marine cabling
- Panel building
- Special applications

Materials

Polyamide 6.6: Characteristics of raw material

Working temperature: -45 °C to 85 °C
 Tightening temperature: -10 °C to 60 °C
 Max admissible point: 120 °C*
 Melting temperature: 256 °C
 Limiting Oxygen Index (LOI): 27 %
 Recovery of moisture: 2.7 % to 50 % relative humidity

Halogen free: Evaluated according to EN 50146.

Flame retardancy according to UL 94-V2

Resistance to external agents

- Excellent resistance to aromatic solvents, bases, oils, fat, petroleum products
- Maintain limited contact with acid
- Not resistant to phenol and chlorinated solvents
- Resistance to UV (black colored cable ties)**

Information

EC directives

The material used to produce our cable ties complies with the following EC directives:

- 2000/53/EC (VHU)
- 2002/65/UE (RoHS)
- 2002/96/EC (DEEE)
- 2006/95/EC

* (for a short time)

** The black cable ties are loaded with carbon black. Therefore they possess UV resistance according to standard ISO QUV-B 4892 (150 hours), equivalent to 3 years of exposure to sunlight. They are also particularly recommended for external applications.

Technical data & Ordering information

NORMAFIX® CABLE TIES										
Width	Designation	Length in mm	Maximum diameter in mm	Resistance to traction in kgs	White Product No.	Black Product No.	Red Product No.	Yellow Product No.	Green Product No.	Blue Product No.
2.5	CABLE TIE 2.5 x 98	98	21	8	0860 0110 201	0860 0210 201	0860 0310 201	0860 0320 201	0860 0330 201	0860 0340 201
2.6	CABLE TIE 2.6 x 160	160	40	8	0860 0110 302	0860 0210 302				
3.5	CABLE TIE 3.5 x 140	140	35	13	0860 0110 401	0860 0210 401	0860 0310 401	0860 0320 401	0860 0330 401	0860 0340 401
	CABLE TIE 3.5 x 200	200	50	13	0860 0110 402	0860 0210 402	0860 0310 402	0860 0320 402	0860 0330 402	0860 0340 402
	CABLE TIE 3.5 x 290	290	80	13	0860 0110 403	0860 0210 403				
	CABLE TIE 3.5 x 370	370	103	13	0860 0110 404	0860 0210 404				
4.5	CABLE TIE 4.5 x 120	120	24	20	0860 0110 501	0860 0210 501				
	CABLE TIE 4.5 x 160	160	40	20	0860 0110 502	0860 0210 502				
	CABLE TIE 4.5 x 200	200	50	22	0860 0110 602	0860 0210 602	0860 0310 601	0860 0320 601	0860 0330 601	0860 0340 601
4.8	CABLE TIE 4.8 x 178	178	45	22	0860 0110 601	0860 0210 601				
	CABLE TIE 4.8 x 250	250	68	22	0860 0110 603	0860 0210 603				
4.5	CABLE TIE 4.5 x 290	290	79	22	0860 0110 604	0860 0210 604	0860 0310 602	0860 0320 602	0860 0330 602	0860 0340 602
	CABLE TIE 4.5 x 360	360	103	22	0860 0110 605	0860 0210 605				
4.8	CABLE TIE 4.8 x 390	390	106	22	0860 0110 606	0860 0210 606				
4.5	CABLE TIE 4.5 x 430	430	115	22	0860 0110 607	0860 0210 607				
7.8	CABLE TIE 7.8 x 180	180	45	55	0860 0110 702	0860 0210 702				
	CABLE TIE 7.8 x 240	240	63	55	0860 0110 703	0860 0210 703				
	CABLE TIE 7.8 x 300	300	80	55	0860 0110 704	0860 0210 704				
7.5	CABLE TIE 7.5 x 365	365	100	55	0860 0110 705	0860 0210 705				
	CABLE TIE 7.5 x 450	450	130	55	0860 0110 706	0860 0210 706				
	CABLE TIE 7.5 x 540	540	158	55	0860 0110 707	0860 0210 707				
	CABLE TIE 7.5 x 750	750	200	55	0860 0110 708	0860 0210 708				
9	CABLE TIE 9 x 780	780	233	77	0860 0110 801	0860 0210 801				
12.5	CABLE TIE 12.5 x 500	500	143	110	0860 0110 902	0860 0210 902				
	CABLE TIE 12.5 x 1000	1000	302	110	0860 0110 905	0860 0210 905				



NORMAEXTRA® – Kits and Displays

A wide range of kits and displays

NORMA® assortments section offers the possibility of having several clamp diameters in one package. All the accessories and the tools mentioned in this chapter are proposed to enable simple and easy installation of the NORMA® products.



NORMAEXTRA

NORMAFIX® NORMETTA® Mini repair kits



NORMACLAMP® QUICK LOCK BAND-ON-ROLL					
Width in mm	Designation	Length in m	Number of closures	Closure type	W1 Product No.
5	MINI REPAIR KIT 8/5	8	25	NB-A5	0560 8520 003
9	MINI REPAIR KIT 8/9	8	25	NB-A9	0560 8520 001

NORMACLAMP® Quick Lock Band-on-roll



NORMACLAMP® QUICK LOCK BAND-ON-ROLL					
Width in mm	Designation	Length in m	Number of closures	W2 Product No.	W4 Product No.
9	BAND-ON-ROLL 3M	3	8	0815 7121 001	0815 7131 001
	BAND-ON-ROLL 5M	5	8	0815 7121 003	0815 7131 003
12	BAND-ON-ROLL 3M	3	6	0815 6007 002	
	BAND-ON-ROLL 5M	5	6	0815 6007 004	

NORMAEXTRA

NORMACLAMP® Quick Lock Band-on-roll dispenser



NORMACLAMP® QUICK LOCK BAND-ON-ROLL DISPENSER				
Width in mm	Designation	Length in m	W2 Product No.	W4 Product No.
9	BAND-ON-ROLL 3M	3	0815 5007 015	0815 5007 014
	BAND-ON-ROLL 5M	5	0815 5007 017	0815 5007 016

NORMACLAMP® TORRO® Dispenser



NORMACLAMP® TORRO® DISPENSER				
Width in mm	Designation	Clamping range in mm	Quantity	W2 Product No.
7.5	TORRO 8 - 12/7.5	8 - 12	10	0126 9702 010
9	TORRO 8 - 16/9	8 - 16	10	
	TORRO 12 - 22/9	12 - 22	10	
	TORRO 16 - 27/9	16 - 27	10	
	TORRO 20 - 32/9	20 - 32	10	
	TORRO 25 - 40/9	25 - 40	10	
	TORRO 32 - 50/9	32 - 50	10	
	TORRO 40 - 60/9	40 - 60	10	
	TORRO 50 - 70/9	50 - 70	10	
TORRO 60 - 80/9	60 - 80	10		

NORMACLAMP® TORRO® Assortment type 120 pcs



NORMACLAMP® TORRO ASSORTMENT TYPE 120 PCS					
Width in mm	Designation	Clamping range in mm	Quantity	W1 Product No.	W4 Product No.
9	TORRO 8 - 16 /9	8 - 16	40	0126 5005 012	0126 5005 014
	TORRO 12 - 22/9	12 - 22	25		
	TORRO 16 - 27/9	16 - 27	20		
	TORRO 20 - 32/9	20 - 32	15		
	TORRO 25 - 40/9	25 - 40	10		
	TORRO 35 - 50/9	35 - 50	10		
NA	FLEXIDRIVER	NA	1		

NOTES

A series of horizontal dotted lines for writing notes.

A series of horizontal dotted lines for writing notes.

NOTES

A series of horizontal dotted lines for writing notes.

NORMA[®] – User Information

Installation instructions

You can download the assembly instructions for our NORMACONNECT[®] FGR range on our NORMA website: <https://www.norma-connects.com/en/downloads>
Alternatively, or if you are missing any other information, please don't hesitate to get in touch with us: norma-connects@normagroup.com



NORMA® Infrastructure Catalogue

Discover our complete portfolio

We share our expertise

NORMA Catalogue

qrco.de/norma-catalogue-en



ABA Catalogue

qrco.de/ABAcatalogue-en



Irrigation Catalogue

qrco.de/Irrigation-catalogue-en



Leverage our expertise

Benefit from our long-term expertise in the field of joining and fluid handling technology. Here you will learn how to win time, save money and enjoy peace of mind with our products!



Want to get in touch? We'd love to connect with you!

NORMA Group Holding GmbH
Edisonstraße 4
63477 Maintal | Germany

+49 6181-403-0
norma-connects@normagroup.com

Your local distributor:

NORMA Group Holding GmbH | Edisonstraße 4 | 63477 Maintal | Germany | normagroup.com

This document supersedes all previous issues. No part of this publication may be reproduced without our prior written consent. In NORMA Group's policy of continual product improvements to meet user needs and technological developments, all models and sets listed in this folder (photographs, specifications, sizes and weights) may be upgraded or discontinued without notice and without any obligation on our part to modify tools or equipment sold previously. The recommendations for use and safety given in this folder do not replace accepted good practice or the safety related legal and regulatory provisions. References to standards implemented as of February 27, 2023 are not contractually binding.