

NORMA Group SE

Third Quarter Results 2019

Maintal, November 6, 2019

Highlights Q3 2019



Sales

Up by 2.2% to EUR 274.0 million (Q3 2018: EUR 268.1 million).

Adjusted EBITA

EUR 38.7 million resp. -9.5% y-o-y (Q3 2018: EUR 42.8 million).

Margin

Adjusted EBITA margin of 14.1% (Q3 2018: 16.0%).

Net Operating Cash Flow

Net operating cash flow of EUR 37.4 million (Q3 2018: EUR 23.0 million); further decrease of ABS and Factoring programs by EUR 6.6 million to EUR 60.0 million as of Sept 30, 2019 (Jun 30, 2019: EUR 66.6 million).

Balance Sheet

Equity ratio as of September 30, 2019 at 40.9% (Dec 31, 2018: 40.9%).

Net debt as of Sept. 30, 2019 increased by 15.9% to EUR 462.9 million (Dec 31, 2018: EUR 399.6 million).*

EPS

Earnings per share decreased by 21.9% to EUR 0.52 (Q3 2018: EUR 0.66)

Adjusted earnings per share decreased by 12.1% to EUR 0.73 (Q3 2018: EUR 0.83)

Guidance 2019

Organic growth of around -4% and -2%, plus around EUR 13 million from acquisitions.

Adjusted EBITA margin of more than 13%.

“Get on track”

Additional optimization program “Get on track” started, focusing on operational excellence and structural improvements

*This increase is mainly attributable to the increase in financial liabilities due to the first-time adoption of IFRS 16 in 2019 as a result of liabilities from capitalized leases (EUR 39.8 million)

Organic growth development flat in Q3 2019

Sales Development in EUR million							
Sales	2018	2019	Change	Change in %	Thereof organic	Thereof acquisitions	Thereof currency
Q1	272.6	275.6	+ 3.0	+ 1.1%	- 4.2%	+ 2.3%	+ 3.1%
Q2	276.4	289.0	+ 12.6	+ 4.6 %	- 0.4%	+ 2.4%	+ 2.5 %
Q3	268.1	274.0	+ 5.9	+ 2.2%	- 0.1%	+ 0.2%	+ 2.1%
Q1-Q3	817.1	838.6	+ 21.5	+ 2.6%	- 1.6%	+ 1.6%	+ 2.6%

Regional Split (in % actual vs. (prev. year))

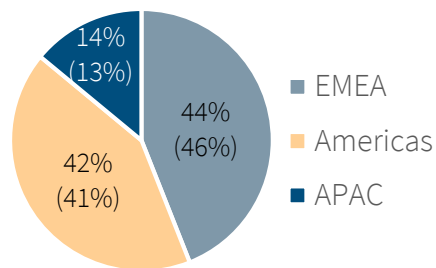

Sales Development*

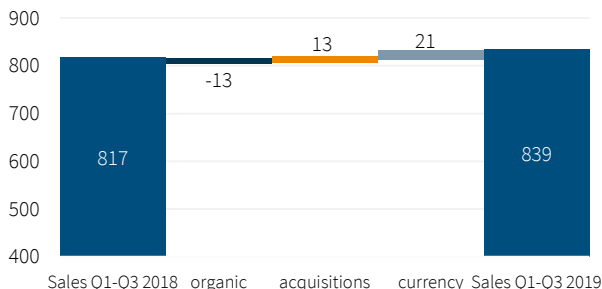

Negative organic growth of 1.6% in Q1-Q3 2019 resulting from

- a weak EJT business in all regions, especially in North America
- strong organic growth of the US water business
- EUR 10.4 million sales contribution from the acquisitions of Kimplas and EUR 2.9 million from Statek
- EUR 21.1 million currency effects

Sales by Region in Q1-3 2019



Net Sales (in EUR million)

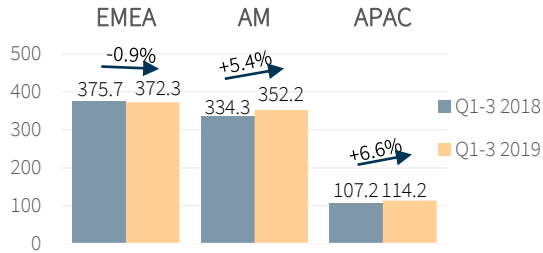

Organic Growth (in EUR million)

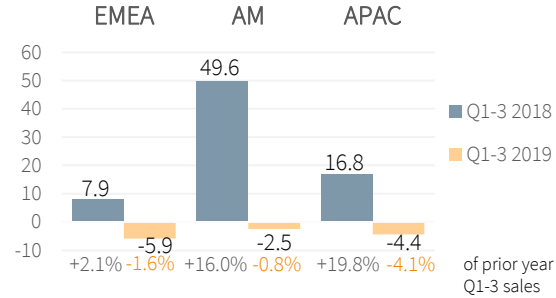

Acquisitions (in EUR million)

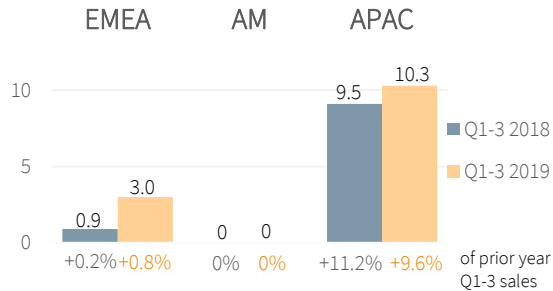

Currency Effects (in EUR million)

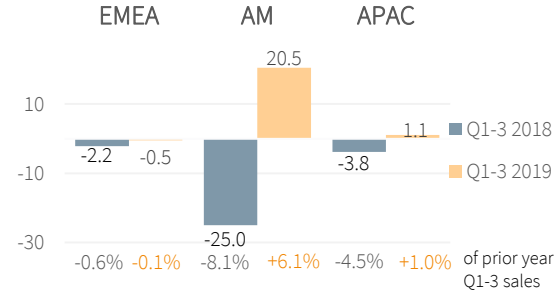

EMEA

Organic decline at -1.6% due to lower production and sales in the automotive business plus negative currency effects of -0.1% and acquisition effects of +0.8% led to a total sales decline of -0.9%.

Americas

Organic decline at -0.8% due to a weak EJT business, while strong growth of NDS plus positive currency effects of 6.1% led to a total sales increase of +5.4%.

APAC

Organic decline at -4.1% due to a weak environment in the Chinese auto sector plus acquisition effects of EUR 10.3 million or +9.6% plus currency effects of +1.0% led to a total sales increase of 6.6%.

Margin Development

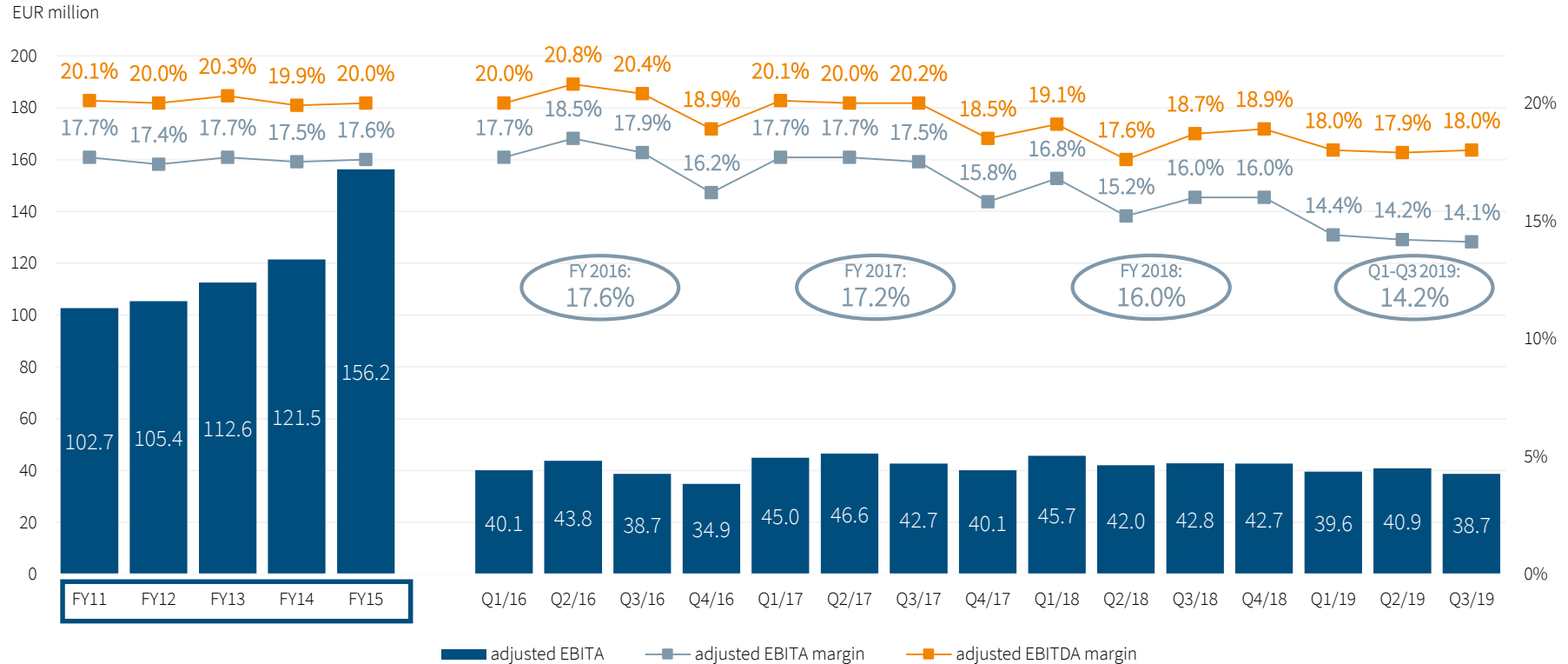

Adjusted P&L Development

- Lower material cost ratio in Q3 2019 due to prior year built-up of finished goods and work in progress (P&L total cost method)
- Gross profit margin decreased in Q3 2019 compared to Q3 2018
- Personnel expenses ratio in Q3 higher at 27.5% (Q3 2018: 26.0%) due to severance payment for a former Board Member and prior years' bonus provisions release
- Other operating income and expenses amount decreased by EUR 8.5 million in Q1-Q3 2019 (Q3 2019: EUR 2.9 million) due to the first-time adoption of IFRS 16
- Adjusted EBITA margin in Q3 2019 decreased by 190 BP to 14.1% compared to the previous year; compared to Q2 2019 nearly stable adjusted EBITA margin

Material Costs

(in EUR million and % of sales)

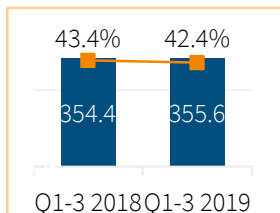
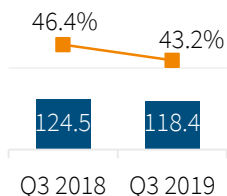

Gross Profit

(in EUR million and % of sales)

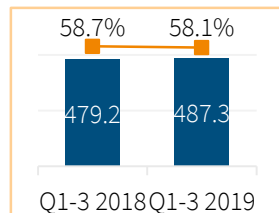
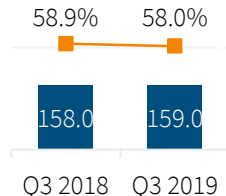

Adjusted Personnel Expenses

(in EUR million and % of sales)

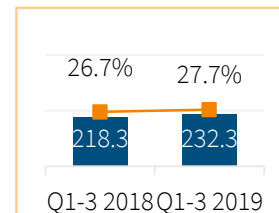
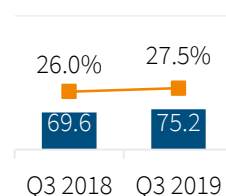

Net Expenses from adj. other oper. Income and Expenses

(in EUR million and % of sales)

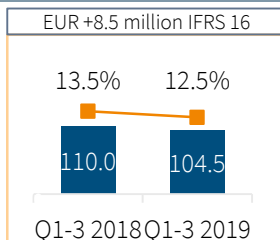
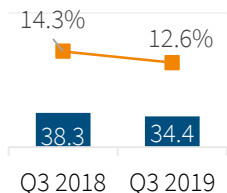

Adjusted Depreciation

(in EUR million and % of sales)

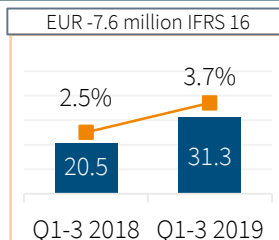
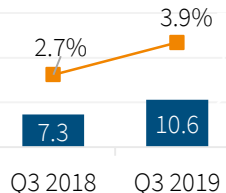

Adjusted EBITA

(in EUR million and % of sales)

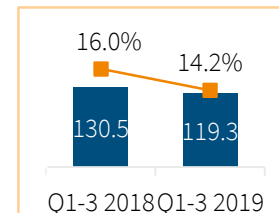
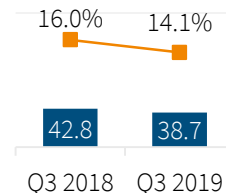

Operational Adjustments in Q1-Q3 2019

- Operational adjustments on EBITDA level mainly due to the rightsizing program (thereof EUR 9.2 million for employee benefit expenses).
- Additional EUR 19.4 million PPA adjustments on EBIT level.
- Total adjustment per share after tax of EUR 0.72.

in EUR million*	Reported	Adjustments	Adjusted
Sales	838.6		838.6
EBITDA	138.5	12.1 (incl. EUR 0.4 million integration costs and EUR 11.7 million Rightsizing costs)	150.6**
EBITDA margin	16.5%		18.0%
EBITA	104.6	14.6 (incl. EUR 2.6 million depreciation PPA)	119.3***
EBITA margin	12.5%		14.2%
EBIT	81.4	31.5 (incl. EUR 16.8 million amortization PPA)	112.9
EBIT margin	9.7%		13.5%
Net Profit	51.2	23.0 (incl. EUR -8.5 million post tax impact)	74.2
Net Profit margin	6.1%		8.8%
EPS (in EUR)	1.61	0.72	2.33

* Deviations may occur due to commercial rounding.

** The first-time adoption of IFRS 16 had a positive impact of EUR 8.5 million on other operating expenses.

*** The first-time adoption of IFRS 16 had a negative impact of EUR 7.6 million on depreciations.

EPS Development in Q1-3 2019



Adjusted EPS*

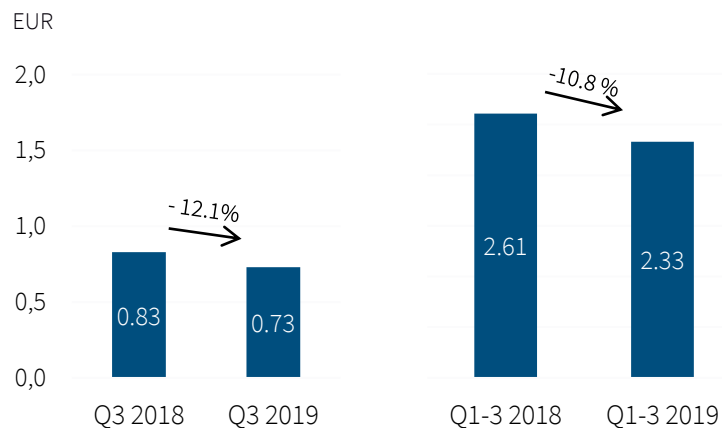

Reported EPS*

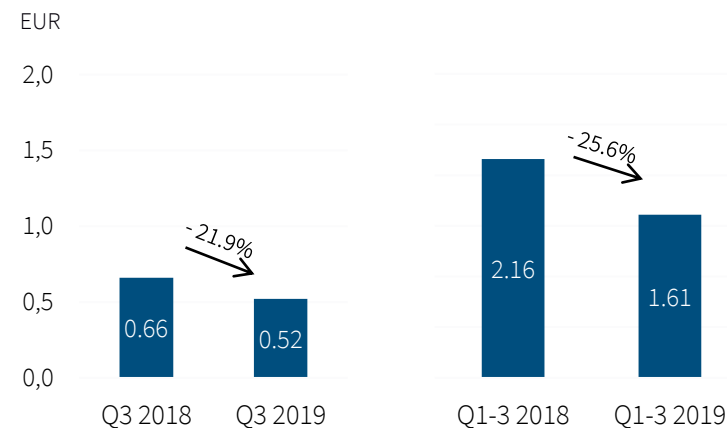

Net Income in
EUR million

26.5

23.3

83.4

74.2

21.0

16.4

68.9

51.2

* Based on number of shares of 31,862,400

Net Debt and Net Debt Ratios

- Net debt increases by EUR 63 million or 15.9% to EUR 463 million, thereof EUR 40 million due to new IFRS 16 and EUR 35 million dividend payment in Q2 2019
- Leverage increases to 2.2x (2018: 1.9x) mainly due to higher net debt*
- Equity ratio at 40.9% (Dec 31, 2018: 40.9%) despite of dividend payment in May 2019.

Net Debt* (in EUR million)

in EUR million

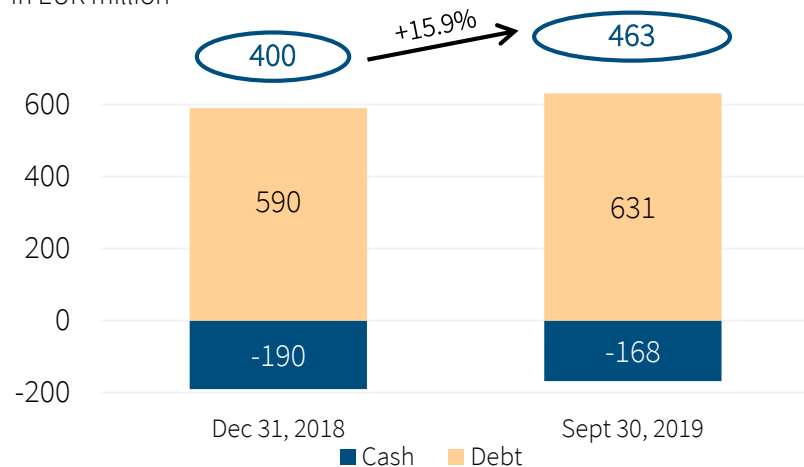

Equity Ratio

	Dec 31, 2018	Sept 30, 2019
Equity Ratio (equity / balance sheet total)	40.9%	40.9%

Debt Ratios

	Dec 31, 2018	Sept 30, 2019
Leverage (Net debt / adjusted EBITDA**)	1.9 x	2.2
Gearing (Net debt / equity)	0.7 x	0.7x

* Leverage including IFRS 16: 2.3x

** Adjusted EBITDA includes full year effect from the acquisitions of Kimplas and Statek

Net Operating Cash Flow Development



Net Operating Cash Flow*

in EUR million	Q1-3 2018	Q1-3 2019	Variance	Q3 2018	Q3 2019	Variance
Adjusted EBITDA	151.0	150.6	-0.2%	50.1	49.4	-1.4%
Δ ± Trade Working capital	-67.2	-49.9	-25.6%	-9.3	-1.3	-86.0%
Net operating cash flow before investments from operating business	83.8	100.7	+20.1%	40.8	48.0	+17.9%
Δ ± Investments from operating business	-44.4	-34.7	-21.8%	-17.8	-10.7	-40.2%
Net Operating Cash Flow	39.4	65.9	+67.4%	23.0	37.4	+62.6%

- Adjusted EBITDA including positive effect from the first-time adoption of IFRS 16 (Q1-Q3 2019: EUR 8.5 million; Q3 2019: EUR 2.9 million)
- ABS- and (Reverse-) Factoring programs decreased by EUR 20.4 million to EUR 60.0 million (September, 30th 2019) vs. EUR 80.4 million (December, 31st 2018)
- CAPEX spending of EUR 34.7 million mainly for manufacturing facilities in Germany, the UK, Poland, Serbia, France, China, India, Mexico and the US.
- Without IFRS 16 (EUR 8.5 million) and ABS-Factoring reduction (EUR 20.4 million) Net operating cash flow at EUR 77.8 million vs. EUR 39.4 million prior year (+ EUR 38.1 million)

* Deviations may occur due to commercial rounding.

NORMA Value Added (NOVA)



NORMA Value Added

in EUR million	2017	2018	Q3 2018	Q3 2019	Q1-3 2018	Q1-3 2019
Adjusted EBIT after taxes	116.2	123.5	29.4	26.1*	90.8	82.4*
Capital Cost (WACC x CE per January 1st)	-61.4	-62.8	15.5	18.1	45.7	53.2
NOVA	54.8	60.8	13.9	8.1**	45.1	29.2**

- NORMA Group's long term strategic target is NORMA Value Added (NOVA).
- In order to manage this, NORMA Group determines the annual value creation.
- NOVA is calculated on the basis of adjusted EBIT, tax rate and the cost of capital.
- The cost of capital is defined by the weighted average cost of capital (WACC) and the capital employed (equity plus net debt).

*IFRS 16-adjusted EBIT after taxes of EUR 82.4 million in Q1-Q3 2019 (Q3: EUR 26.1 million) compared to old accounting standard IAS 17-adjusted EBIT after taxes of EUR 81.7 million in Q1-Q3 2019 (Q3: EUR 26.0 million).

**IFRS 16-NOVA of EUR 29.2 million in Q1-Q3 2019 (Q3: EUR 8.1 million) compared to old accounting standard IAS 17-NOVA of EUR 28.5 million in Q1-Q3 2019 (Q3: EUR 7.9 million).

Change Program „Get on track“ launched



Goal	Performance program will set basis for further strategic development and profitable growth of NORMA Group.
	Key objective to return NORMA to historic profit margin levels.
	Start execution of holistic performance program to increase efficiency and achieve full profit potential across NORMA Group.
	Alignment of whole organization along profitability and cash flow generation.
Benefits	Program is expected to result in a positive earnings contribution (EBITA) per year of around EUR 40 million to EUR 45 million in 2023.
Costs*	Total cost volume accumulated of around EUR 45 million to EUR 50 million in 2023.

*Will be shown on an unadjusted basis.

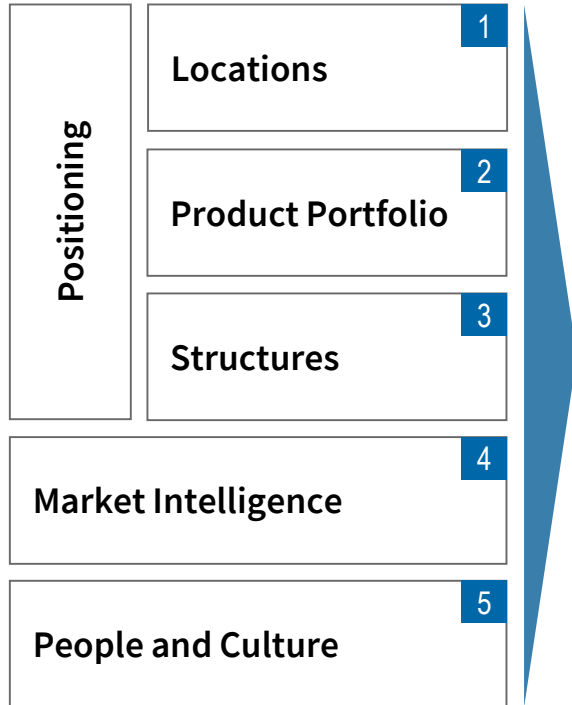

Examples

- Increase share of best cost country production
- Reduction of complexity
- Streamlining of product portfolio through active portfolio management
- Bundle and transfer low volume products and business to wholesaler
- Strengthen commodities strategy
- Focus on best cost country purchasing
- Improvement of structures and processes
- Profound information and transparency on products and markets
- Reliable basis for active portfolio management in structured and transparent systems
- Qualification of personnel according to adjusted processes and structures
- Training of employees

Change Program „Get on track“ financials

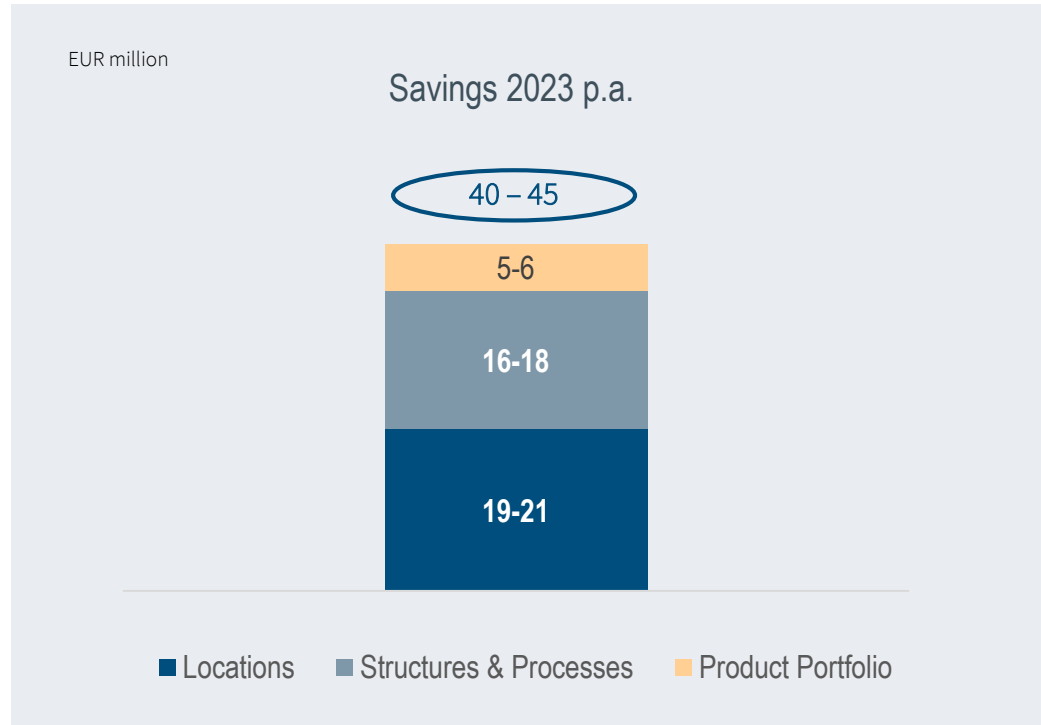

Implementation Costs

- Accumulated total cost volume for implementation of between EUR 45 million and EUR 50 million until 2023.
- Implementation costs will be shown on an unadjusted basis.

Rightsizing Program launched



Rightsizing	Optimization of the production landscape, which has grown rapidly as a result of acquisitions, organizational structures and further harmonization of processes and systems worldwide.
Scope	The optimization measures are to extend across all divisions and regions.
Goal	Further development of the business model to meet the requirements of future strategic growth areas such as electromobility and water management.
Benefit	Program is expected to result in a positive earnings contribution (adjusted EBITA) of around EUR 10 million to EUR 15 million annually from 2021 on.
First Successes	Successful relocation of production activities from Russia to Serbia. Closing of Distribution Center in Netherlands and transfer to an existing Distribution Center.
Costs*	Total cost volume of around EUR 10 million to EUR 15 million in total; thereof EUR 2.2 million in 2018 and EUR 11.7 million in Q1-Q3 2019.

*Will be shown on an adjusted basis.

Outlook 2019 – Company Guidance



Sales	Decline in organic growth of around - 4% to -2% and additionally around EUR 13 million from acquisitions.
Adjusted EBITA Margin	More than 13%.
Adjusted EPS	Strong decrease.
NOVA	Between EUR 20 million and EUR 30 million.
Net Operating Cash Flow	Around EUR 90 million.
Dividend	Approx. 30% to 35% of adjusted net profit for the period.

Appendix



NORMA Group's Key Facts



Specific customer requirements driven by megatrends



Global market and technology leader in joining and fluid handling technology.



Offers more than 40,000 innovative joining solutions in three product categories: Clamp, Connect, Fluid.



Delivers to more than 10,000 customers in 100 countries.



Employees > 9,000 worldwide.



Operates a global network of more than 29 manufacturing facilities.



Numerous sales and distribution sites across Europe, the Americas and Asia-Pacific.



Sales of about EUR 1,084 million in 2018.

Proven Business Model Addressing Key Megatrends

Specific customer requirements driven by megatrends

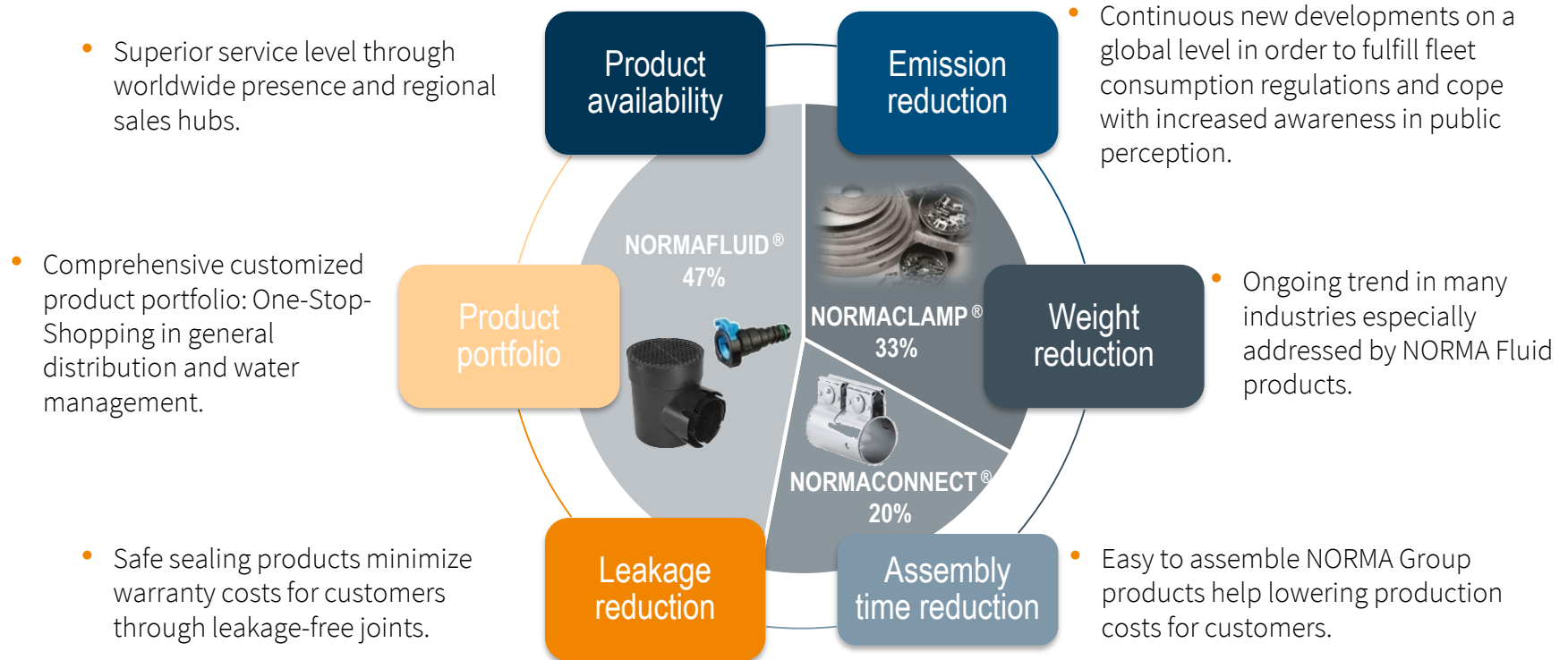

Tighter Emission Regulations Drive Increased Joining Technology Content

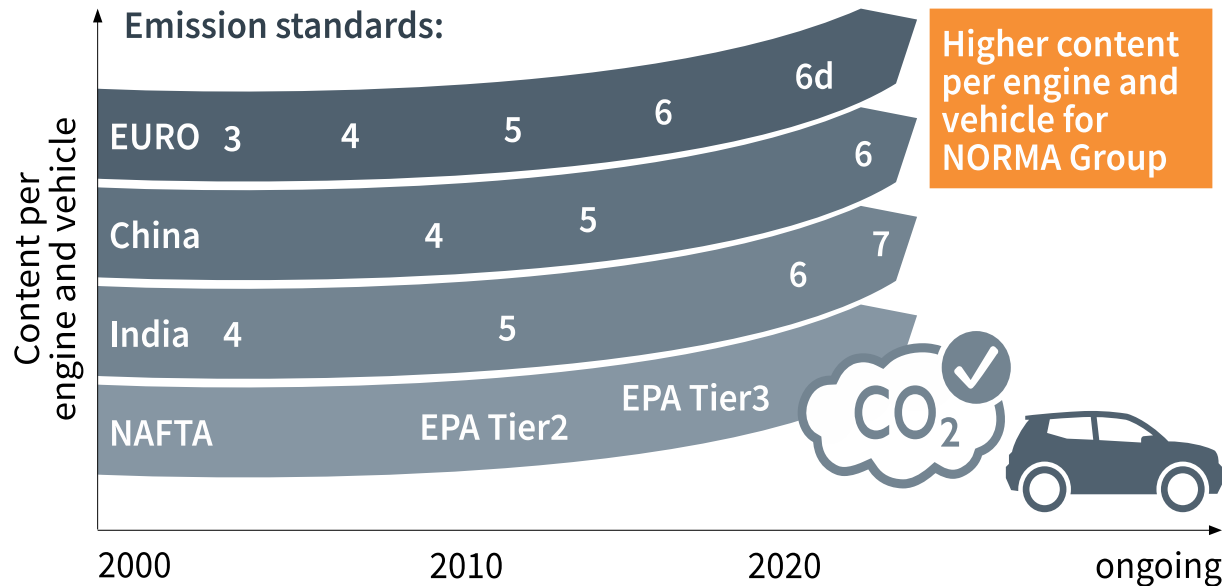

- Environmental awareness continues to drive tightening emission regulations globally, including in emerging markets.
- Low-emission alternatives require significantly higher joining technology content at a substantially increased complexity compared to existing/past technologies.

History of Excellence

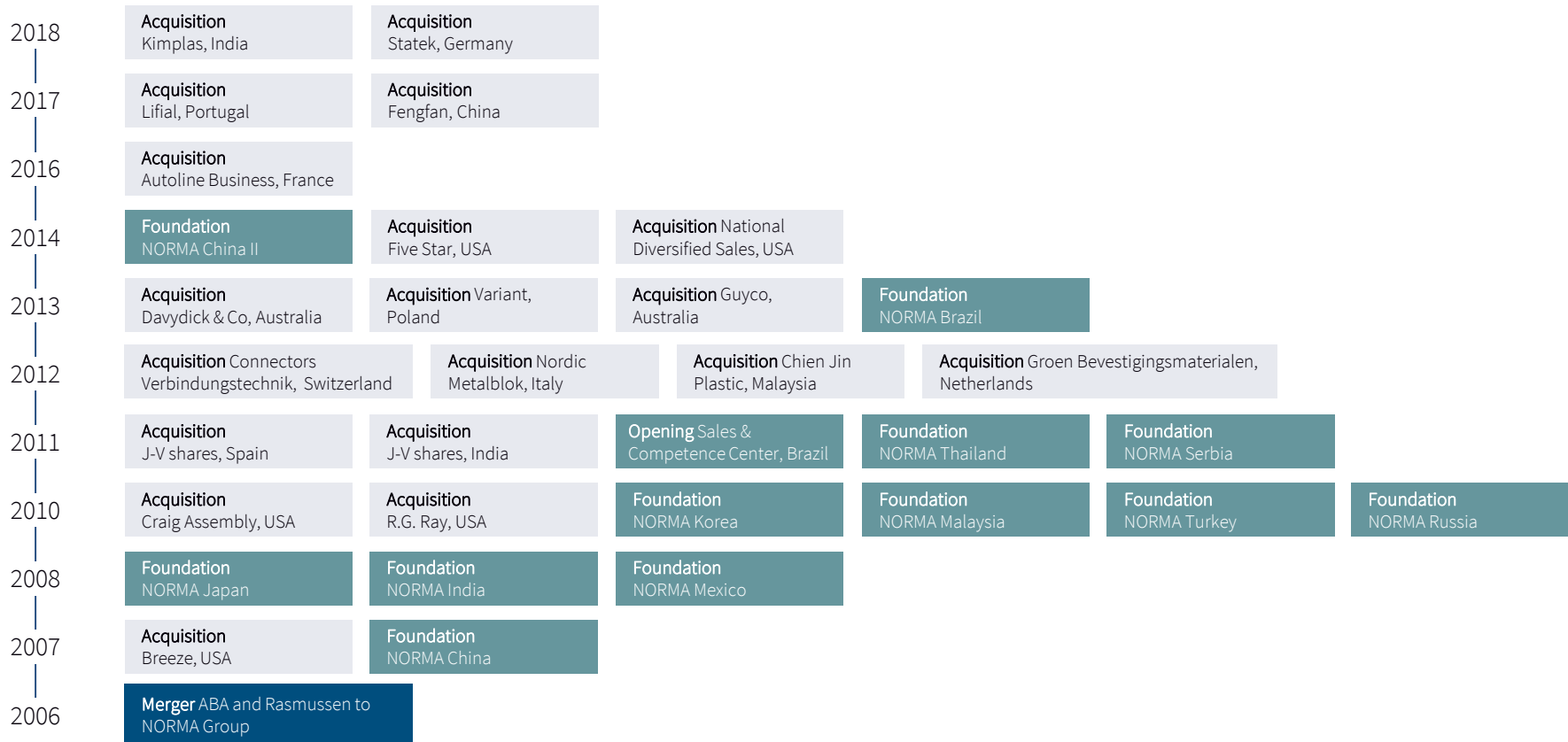

NORMA Group well on Track for Coming E-Mobility Developments



- Battery Thermal Management
- Coolant Systems
- Power Electronics and Motors Cooling
- HVAC / Heat Pump Systems

NORMA Group will benefit from a hybridization and maintain its growth trend with ICE and BEV

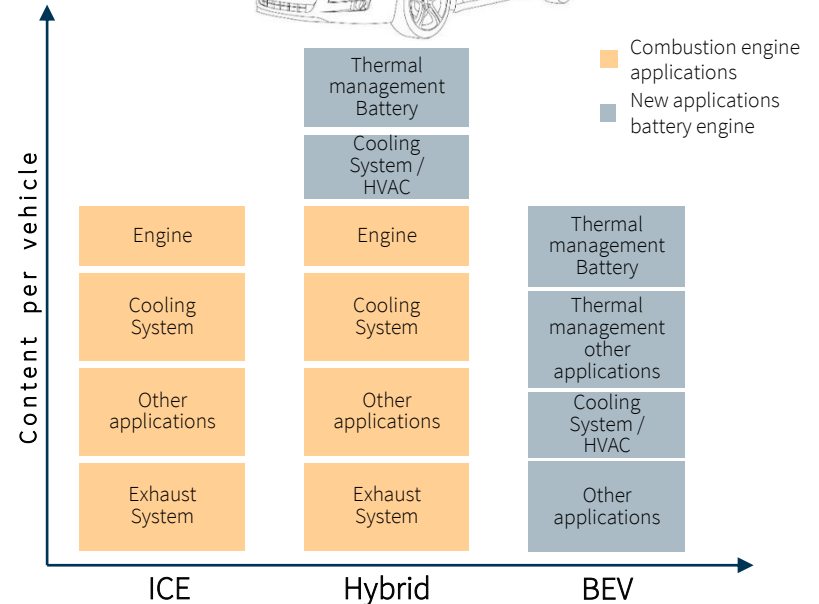
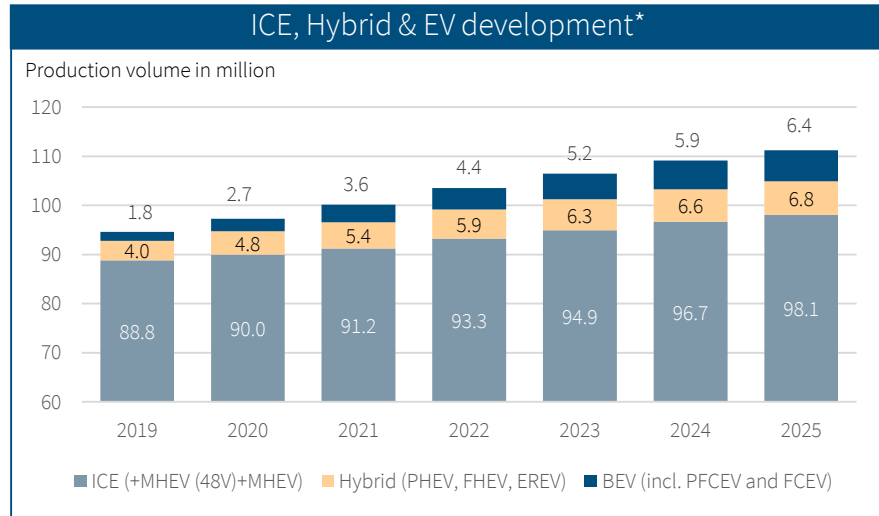

*Source: LMC / NORMA Group as of end of January 2019

14 Acquisitions since the IPO in 2011 representing 46% of Sales in 2011



Sales Consolidation Effects (in EUR million)	Date of Acquisition		Total Sales
CONNECTORS Verbindungstechnik AG, Switzerland	04/12	Market entry in connecting technology in Pharma & Biotech	16.6
Nordic Metalblok S.r.l., Italy	07/12	Market consolidation heating and air conditioning clamps	5.2
Chien Jin Plastic Sdn. Bhd., Malaysia	11/12	Market entry joining elements for water distribution	7.7
Groen Bevestigingsmaterialen B.V., Netherlands	12/12	Securing market with national dealer	3.4
Davydick & Co. Pty. Limited, Australia	01/13	Enforce market position with distribution of water & irrigation systems	3.4
Variant SA, Poland	06/13	Securing market with national dealer	2.3
Guyco Pty. Limited, Australia	07/13	Enforce market position with distribution of water & irrigation systems	7.2
Five Star Clamps Inc., USA	05/14	Consolidation of multi-industrial engineered clamps	4.0
National Diversified Sales, Inc., USA	10/14	Expanding water management product portfolio	129.3
Autoline, France	12/16	Expanding product portfolio and strengthening market position in the area of quick connectors	46.2
Lifial - Indústria Metalúrgica de Águeda, Lda., Portugal	01/17	Strengthening product portfolio of DS business and market consolidation	7.4
Fengfan Fastener (Shaoxing) Co., Ltd., China	05/17	Expanding product portfolio and market position	11.5
Kimplas Piping Systems Ltd., India	07/18	Expanding water management product portfolio	20.5
Statek Stanzereitechnik GmbH, Germany	08/18	Expanding value chain for stamping and forming technology	5.0
Total			269.8

Acquisition of Kimplas Piping Systems Ltd.

M&A

Closing of Kimplas Piping Systems Ltd., India, in July 2018.

Business Model

Leading Indian manufacturer of thermoplastic connection solutions
Based in Nashik, India, with own production site.

History

Since 1996 the company has been developing and manufacturing injection-molded parts used to ensure safe and leakage-free supply of drinking water and gas to rural and urban households and provide filtered water for micro irrigation systems.

Sales

Sales of around EUR 21 million in financial year 2018 (Apr 1, 2017 – Mar 31, 2018).

Consolidation

First time consolidation into NORMA Group started July 2018.

Margin

In the range of NORMA Group's margin.

Financing

Transaction was financed with credit facilities.

Acquisition of Statek Stanzereitechnik GmbH

M&A

Closing of Statek Stanzereitechnik GmbH, Maintal, Germany, in August 2018.

Business Model

Producer of contact and stamped parts, housings, wave springs and other products for electrical engineering and industry purposes.

History

Founded in 1980, Statek has many years of experience and a high level of production expertise in stamping, bending and forming technology for almost all commonly used metals.

Sales

Sales of around EUR 17 million in financial year 2018, thereof around EUR 5 million of external sales.

Consolidation

First time consolidation into NORMA Group started August 2018.

Margin

In the range of NORMA Group's margin.

Financing

Transaction was financed with credit facilities.

Acquisition of the Autoline business from Parker Hannifin



M&A

Acquisition of all assets of the Autoline business from Parker Hannifin in November 2016.

Business Model

Global supplier of quick connectors for all types of automotive fluid line applications
Based in Guichen, France, with production sites in France, Mexico and China.

History

For more than 20 years the company has been designing, manufacturing and marketing quick connectors for fuel lines, cooling lines, vapor lines, braking assistance lines and SCR (Selective Catalytic Reduction) circuit lines.

Sales

Sales of around EUR 40 million in financial year 2016 (Jul 1, 2015 – Jun 30, 2016).

Consolidation

First time consolidation into NORMA Group starting December 2016.

Margin

In the range of NORMA Group's margin.

Financing

Transaction was financed with credit facilities.

Scarce Resource Calling for Water Handling Products

- 17.3% of sales or EUR 187.5 million in 2018
- Production and distribution sites in Australia, Malaysia, the US and India
- Expanding Water Business organically and through M&A transactions

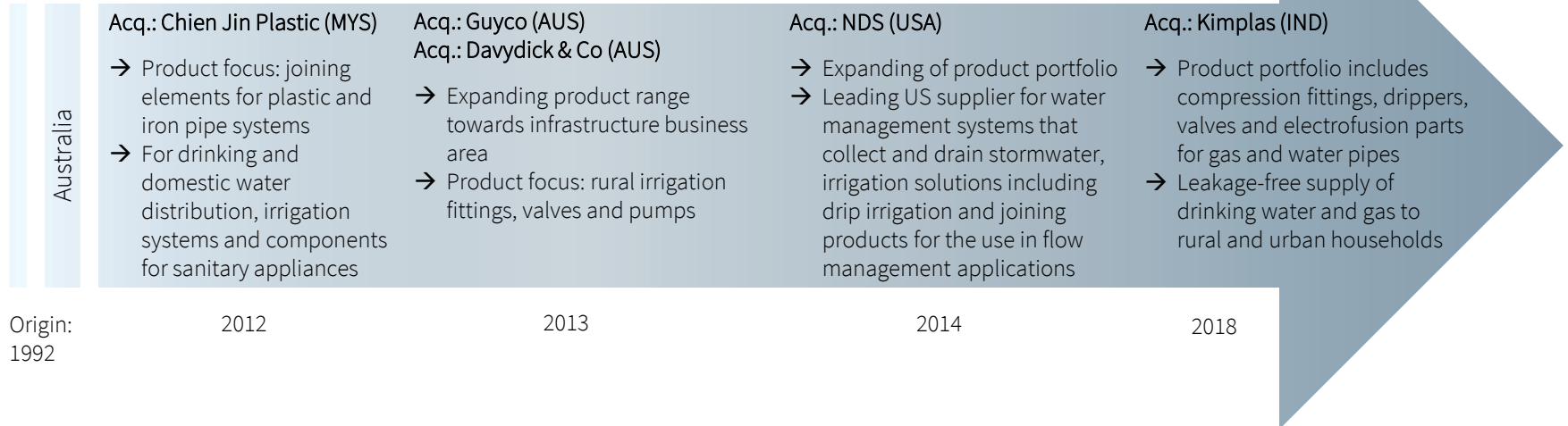

NDS Provides Full Breadth of Water Management Solutions



Broad diversification in terms of application areas and products

**Stormwater
Management**
ca. 55%



**Efficient
Landscape
Irrigation**
ca. 27%

**Flow Management
and Others** ca.
18%



Large target markets for all NDS application areas nationwide and international

International expansion with mid-term focus

NDS has deep and longstanding Customer Relationships



Highly differentiated distribution and service model

- More than 4,100 products
- Over 7,500 customer locations (retail and wholesale customers)
- Two production sites (CA), six warehouses in the US, more than 500 employees
- Overnight shipment for wholesale orders
- 98% on-time delivery

Over 7,500 customer locations

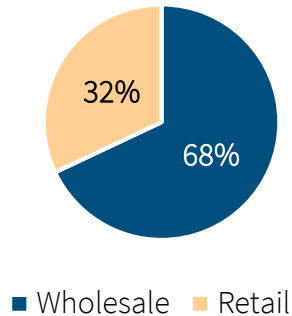

Nation-wide presence

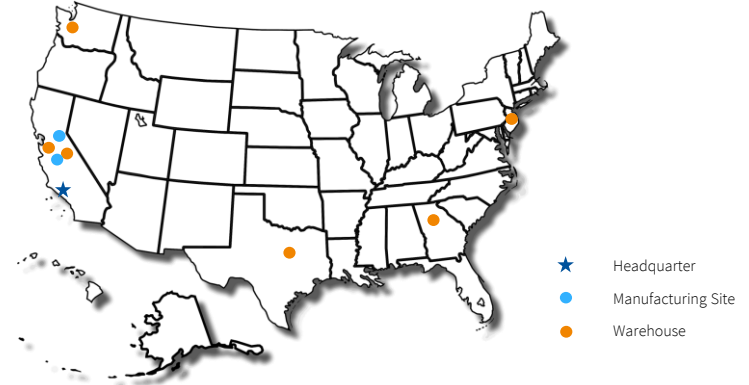

Balanced Industry Mix with Two Strong Ways to Market*

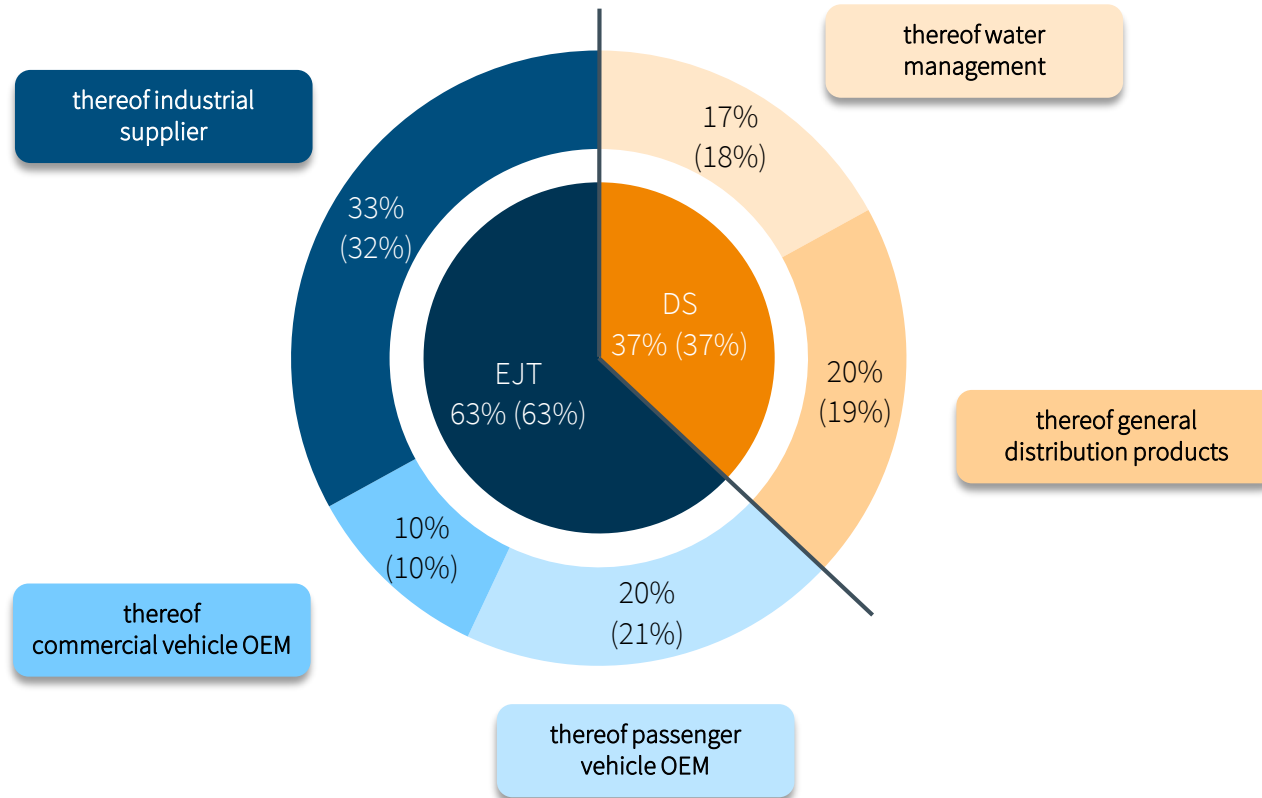

Historic Growth Track Record

Historic Revenue Development in EUR million

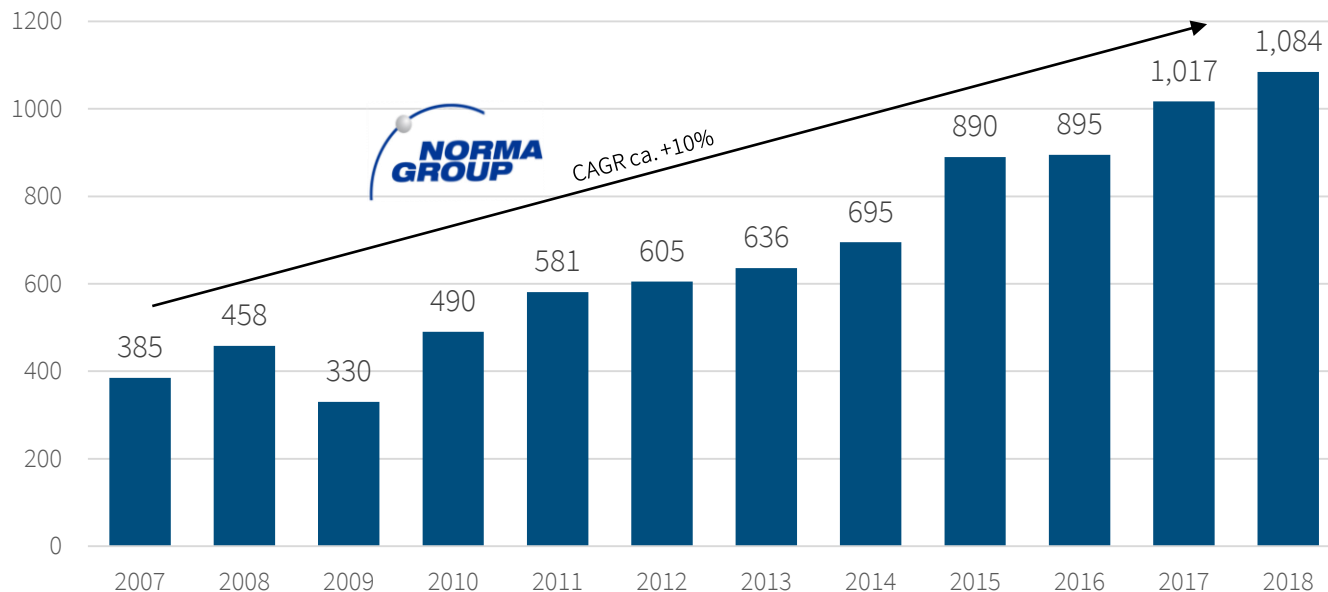

Thereof Organic Growth in EUR million

year	€	%
2011	65.6	13.4%
2012	-10.8	-1.9%
2013	15.1	2.5%
2014	41.3	6.5%
2015	25.9	3.7%
2016	7.6	0.9%
2017	77.0	8.6%
2018	78.6	7.7%
Ø eight years		5.2%

2007 to 2018: 12 years of ca. 10% CAGR

Convincing Growth Prospects

Clear global market leader in Clamp / Connect

Sales in EUR million (year)*

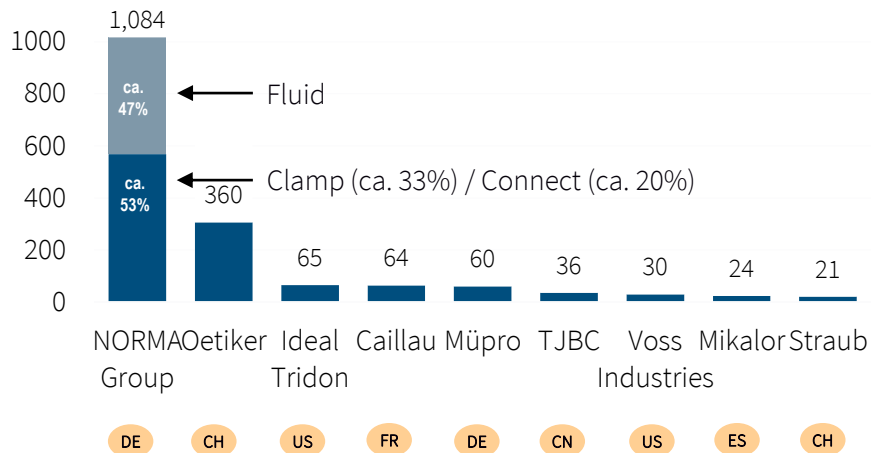

Excellent growth outlook across EJT market

Additional growth for Joining Technology market above market growth

- Passenger vehicles
 - Commercial vehicles
 - Agricultural equipment
 - Construction equipment
 - Engines
 - Water management
- Add. 2-4 %

- NORMA Group expects to grow even faster than its end markets.

Premium Pricing through Technology and Innovation Leadership in Mission-Critical Components

Mission-criticality: Small relative costs – high impact

Basis for premium pricing

Market leadership

Technology

Quality

Innovation

Tailor-made solutions

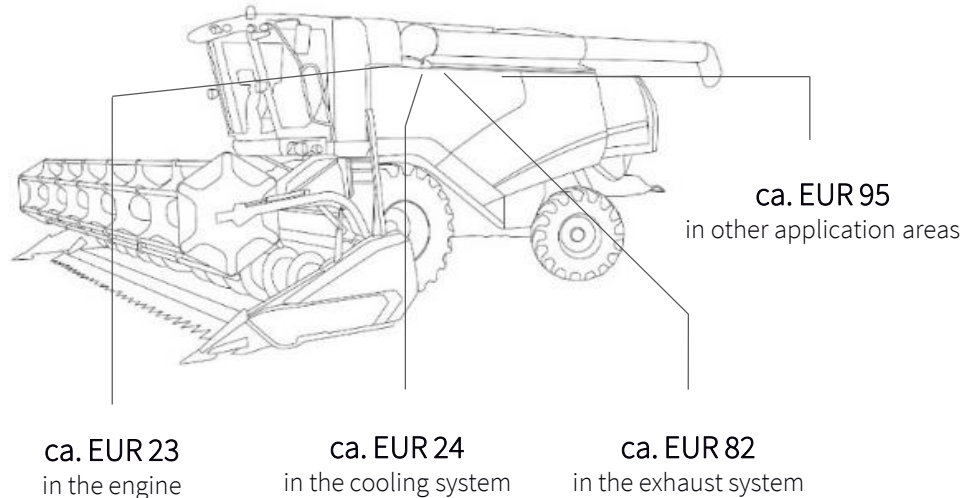

ca. EUR 224
content per vehicle
in total

< 0.1%
content per vehicle

ca. EUR 350,000
costs an average
harvester

High switching costs for customers

Enhanced Stability through Broad Diversification Across Products, End Markets and Regions



Examples of NORMA Group's key end markets



- More than 40,000 products, manufactured in 30 locations and sold to more than 10,000 customers in 100 countries.
- Top 5 customers account only for around 14% of 2018 sales.

Good Balance in the Two Distinct Ways to Market



Distribution Services (DS)
ca. 37% of 2018 sales

Engineered Joining Technology (EJT)
ca. 63% of 2018 sales

High quality, branded and standardized joining products provided at competitive prices to broad range of customers.



- High quality, standardized joining technology products.
- No. 1 product portfolio & service level.
- B2C

Unique business model with two distinct ways-to-market

- Significant economies of scale in production.
- Resident engineers with close contact to international EJT customers.
 - No. 1 national and international DS service level and DS product portfolio.

Innovation and product solution partner for customers, focused on engineering expertise with high value-add.



- Customized, engineered solutions.
- 1038 patents and utility models.
- B2B

NORMA Group Provides Mission-Critical Products and Solutions with Clear Added-Value



A World without NORMA Group



Customer Impact

- Reputation loss
- Image loss
- Warranty costs
- Non-compliance with legal requirements/regulations

Loss of End Customers

What is Corporate Responsibility at NORMA Group?



Find all details in
NORMA Group's [CR Policy](#)

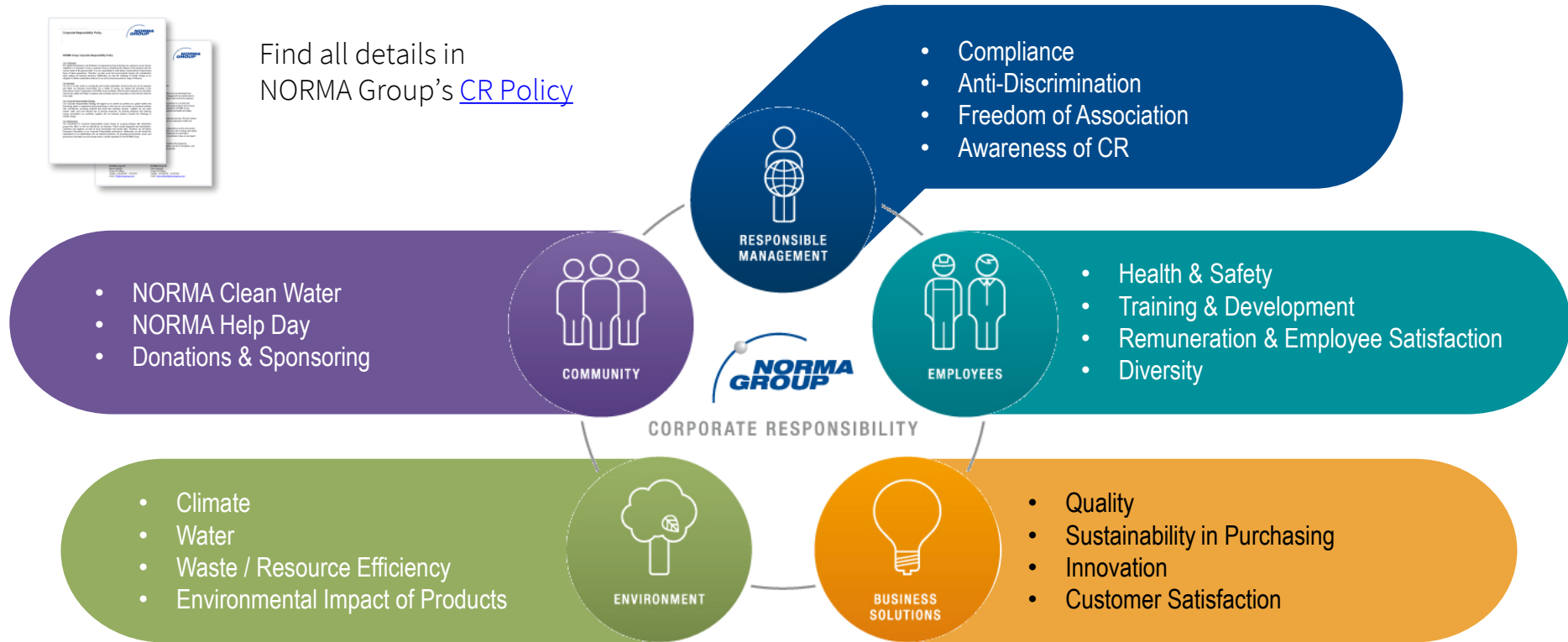

NORMA Group's commitment and CR organization

Commitment

Membership with UN Global Compact

- Ten principles in the areas of human rights, labor, the environment and anti-corruption

Human and Labor Rights

- *“NORMA Group categorically rejects and does not accept any form of violation of human rights.”*

Signatory of Diversity Charter

- *“We deeply respect all colleagues irrespective of gender, nationality, ethnic background, religion or worldview, disability, age, and sexual preference and identity.”*

Global Reporting Initiative (GRI)

- Transparent Reporting in annual CR-Report according to GRI Standards

Organization

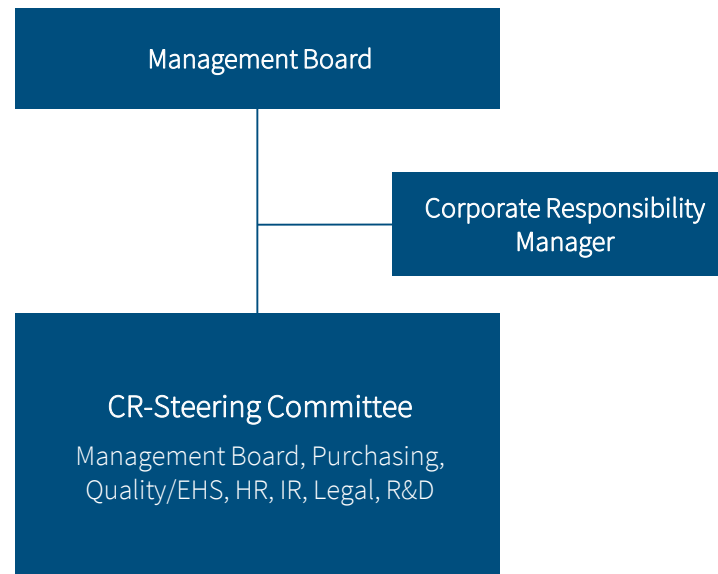

NORMA Group's approach to sustainability / corporate responsibility



Stakeholder communication



Identification of material topics



Reporting



✓ audited

Integration into management

Unsere Ansprache	Meilenstein	Termin	Status
Alle Mitarbeiter kennen die CR-Politik und die zugehörigen Ziele.	100 % Bewusstheit der CR-Politik bis 2018	Erhebung 2018	
Die CR-Initiativen werden in allen Geschäftsprozessen verankert und in der Ausschüttung unserer CR-Strategie und als Zielvorgabe in den einzelnen Funktionsbereichen.	Einmal jährlich ein Dialogprozess mit allen Stakeholdern durchführen	Laufend	Erster Dialog 2018
Die NORMA Group positioniert sich als verantwortungsvoll und nachhaltig handelnde Unternehmen.	Pro Jahr 2 Artikel in CR-Magazinen und 1 Pressemitteilung mit CR-Bezug	Laufend	Wird angestrebt
Wir beschreiben transparent und leicht nachvollziehbar Standards über unsere Performance im nachfolgenden Bericht.	Nachhaltigkeitsbericht alle 2 Jahre mit Daten-Analyse und Bewertung	Laufend	Wird angestrebt
Wir gewährleisten effektives Compliance-Management-Systeme, die der ethischen und rechtlichen Anforderungen in Geschäftsprozessen entsprechen und kommunizieren diese kontinuierlich gegenüber den Mitarbeitern.	Die Compliance Policies, Anzeigensysteme für Compliance und das Meldesystem sind 100 % für Mitarbeiter bekannt	Bis 2018	Erhebung 2018

NORMA Group Worldwide



EMEA

Czech Republic (P)
France (P, D)
Germany (P, D)
Italy (D)
Netherlands (D)
Poland (P, D)
Portugal (P)
Russia (P, D)
Serbia (P)
Spain (D)
Sweden (P, D)
Switzerland (P, D)
Turkey (D)
United Kingdom (P, D)

Americas

Brazil (P, D)
Mexico (P, D)
USA (P, D)

Asia-Pacific

Australia (D)
China (P, D)
India (P, D)
Indonesia (D)
Japan (D)
Malaysia (P, D)
Singapore (D)
South Korea (D)
Thailand (D)

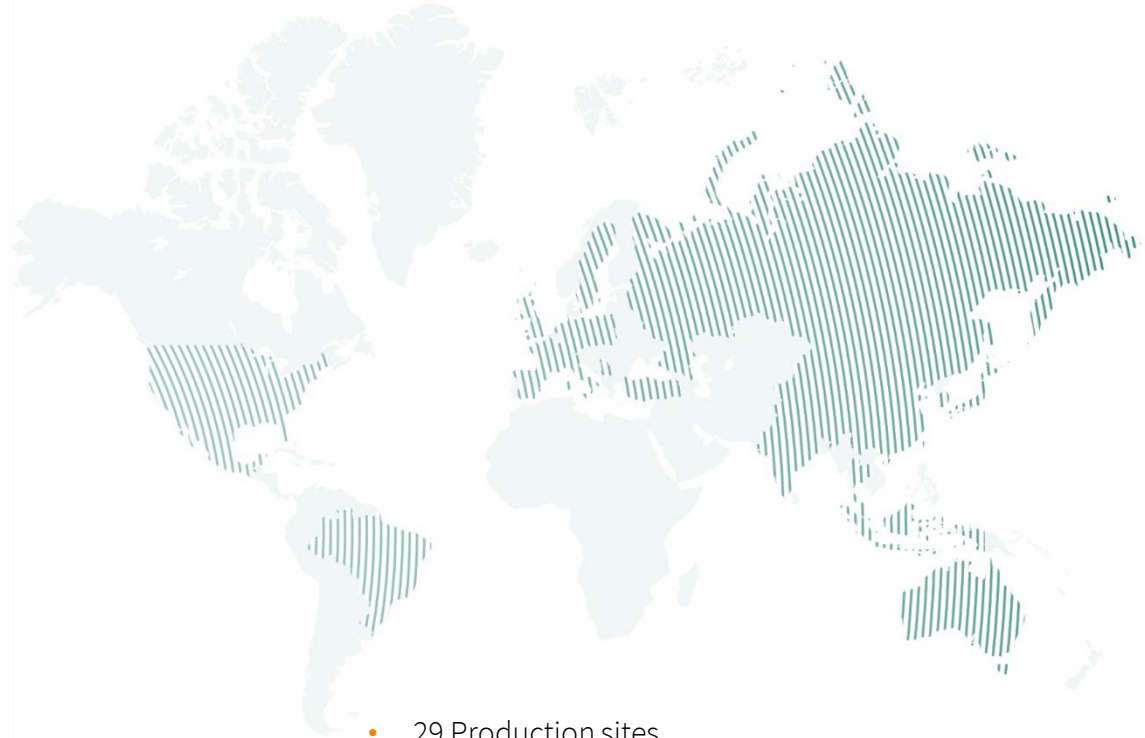

- 29 Production sites
- 23 Countries with Distribution, Sales & Competence Centers
- Sales into more than 100 countries

Highlights 2018 – Strategy



M&A

Successful acquisition of Kimplas Piping Systems Ltd., India, a manufacturer of thermoplastic connection solutions based in Nashik with own production site.

M&A

Successful acquisition of Statek Stanzertechnik GmbH, Maintal, Germany, a producer of contact and stamped parts, housings, wave springs and other products for electrical engineering and industry purposes.

E-Mobility

Increased business volume and development contracts with customers for electric and hybrid passenger cars and trucks.

CR- Roadmap

Further development of environmental strategy: NORMA has set itself quantitative targets in the areas of climate, water and waste.

Vision 2025

Further increase of market share through localization, diversification of the product portfolio and strategic acquisitions to support and extend profitable organic growth.

Outlook 2019 – Strategy

- 1 Continue to develop product and service solutions for  **eMobility**
- 2 Expanding water business.
- 3 Continue to explore business opportunities particularly in Asia-Pacific to expand regional business and further improve profitability.
- 4 Continue dialogue with potential M&A targets in various industries and regions.
- 5 Execution of rightsizing projects as a foundation of further profitable growth.

NORMA Group – Key Investment Highlights

- 1 Market leader in attractive engineering niche markets.
- 2 Strong development and growth opportunities in e-mobility and water management.
- 3 Enhanced stability through broad diversification across products, end markets and regions.
- 4 Engineered products with premium pricing through technology and innovation leadership in mission-critical components.
- 5 Strong global distribution network with one-stop-shopping service to specialized dealers, wholesalers and distributors.
- 6 Significant growth and value creation opportunity through synergistic acquisitions.
- 7 Proven track record of operational excellence.

Management Board of NORMA Group SE



Dr. Michael Schneider



**Member of the Management Board,
CFO of NORMA Group SE
since July 1, 2015**

Responsibilities:

Finance & Reporting, Controlling, Investor Relations,
Treasury & Insurances, Legal and M&A, Risk Management,
Compliance, Internal Audit, Corporate Responsibility

Group Development, Group Communications, Sales, Marketing, Personnel

Professional background

- 2010 – 2015: Managing Director / CFO, FTE automotive Group
- 2006 – 2009: Member of the Management Board, Veritas AG
- 2003 – 2006: CFO, Aesculap AG (B. Braun Melsungen Group)
- Previous: Various international management positions, thereof 3 years in Brazil

Studies / professional education

- Master's degree in business economics at the Justus-Liebig-University of Gießen
- PhD in Economics at the Justus-Liebig-University of Gießen

Dr. Friedrich Klein



**Member of the Management Board,
COO of NORMA Group SE
since October 1, 2018**

Responsibilities:

Production, Purchasing, Supply Chain Management,
Operational Global Excellence, Quality, ICT, ESG

Product Development & Management, R&D

Professional background

- 2008-2018: various leading positions at Schaeffler Technologies AG & Co KG, Herzogenaurach
- 2005-2007: Director of Operations at Mubea Inc, Florence, USA
- 1996-2004: Various leading positions at Muhr und Bender KG, Attendorn
- 1989-1996: Various leading positions at WZL der RWTH Aachen, Aachen

Studies / professional education

- Master's degree in Mechanical Engineering from RWTH Aachen
- Doctorate in Engineering from RWTH Aachen

Appendix



Highlights 2018 – Financials (I)

Sales

Sales of EUR 1,084.1 million (2017: EUR 1,017.1 million) leads to growth of 6.6%.

Adjusted EBITA

Adjusted EBITA of EUR 173.2 million (2017: EUR 174.5 million).

Margin

Adjusted EBITA margin at 16.0% (2017: 17.2%).

EPS

Strong adjusted EPS of EUR 3.61 (2017: EUR 3.29).
Reported EPS declined to EUR 2.88 (2017: EUR 3.76) due to prior years US tax effect.

NOVA

NORMA Value Added* at EUR 60.8 million (2017: EUR 54.8 million).

* NOVA = [adj. EBIT x (1-t)] – (WACC x capital employed per January 1st)

Highlights 2018 – Financials (II)

Equity

Strong balance sheet with an equity ratio of 40.9% (2017: 40.7%) despite dividend and acquisition payments and higher balance sheet total.

Net Debt

Net debt increased to EUR 399.6 million (2017: EUR 343.5 million) including dividend and acquisition payments.

Leverage

Net debt / adj. EBITDA leverage increased to 1.9x (2017: 1.7x).

Net Operating Cash Flow

Lower net operating cash flow of EUR 124.4 million (2017: EUR 132.9 million) due to higher CAPEX investments for future profitable growth.

Dividend

Dividend proposal to the AGM of EUR 1.10 per share, 30.5% or EUR 35.0 million of adjusted net income of EUR 114.8 million.

Guidance 2019

Moderate organic growth of around 1% to 3%, plus around EUR 13 million from acquisitions
Adjusted EBITA margin between 15% and 17%.

Sales by Region

Net Sales (in EUR million)

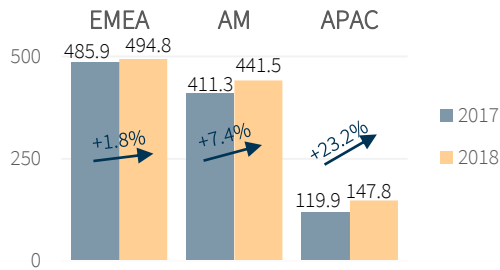

Organic Growth (in EUR million)

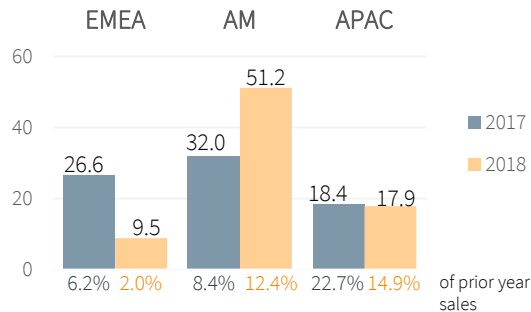

Acquisitions (in EUR million)

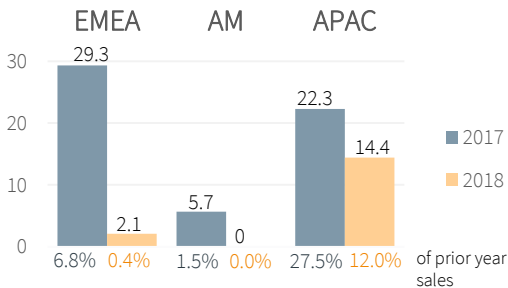

Currency Effects (in EUR million)

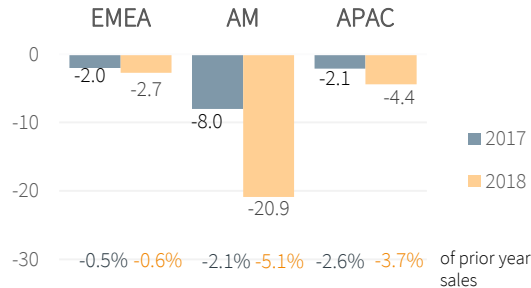

- **EMEA:** Positive EJT and DS sales, negative currency effects and the consolidation of Statek led to a total growth of 1.8%.
- **AM:** Solid increase in EJT sales due to recovery of the commercial vehicle market, solid growth in water sales and negative currency effects led to a growth of +7.4%.
- **APAC:** Strong organic growth in EJT. Negative currency effects and the consolidation of Kimplas and Fengfan led to a total growth of 23.2% for the region.

Sales of EUR 1,084.1 million with excellent Organic Growth of 7.7%



Sales Development in EUR million

Sales	2017	2018	Change	Change in %	Thereof organic	Thereof acquisitions	Thereof currency
Q1	254.9	272.6	17.7	6.9%	13.6%	1.0%	-7.6%
Q2	264.1	276.4	12.3	4.6%	8.5%	0.7%	-4.5%
Q3	244.4	268.1	23.7	9.7%	7.1%	2.5%	0.1%
Q4	253.6	267.0	13.4	5.3%	1.7%	2.4%	1.2%
FY	1,017.1	1,084.1	67.0	6.6%	7.7%	1.6%	-2.8%

Regional Split (in % actual vs. (prev. year))

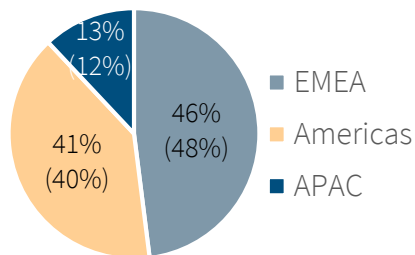

Sales Development

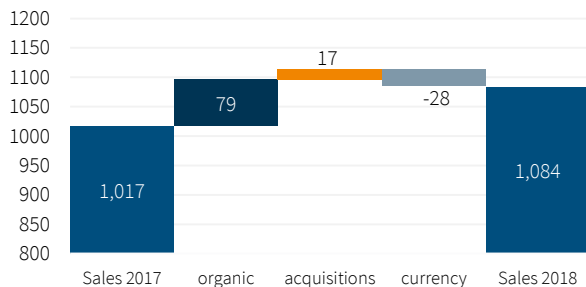

Excellent Organic Growth of 7.7% mainly due to

- an increase of the US production output of the commercial vehicle market
- customer and contract wins especially in APAC
- plus a very good growth in the water management segment.

Adjusted EBITA Development

Adjusted Material Costs

(in EUR million and % of sales)

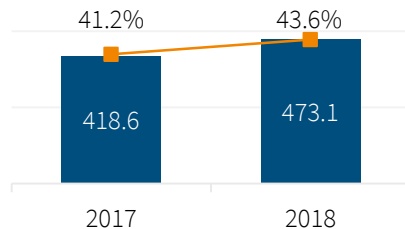

Adjusted Gross Profit

(in EUR million and % of sales)

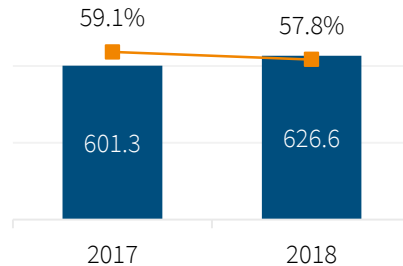

Adjusted Personnel Expenses

(in EUR million and % of sales)

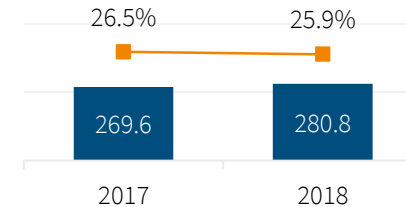

Adj. other oper. Income and Expenses

(in EUR million and % of sales)

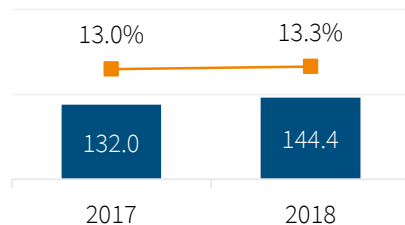

Adjusted EBITA

(in EUR million and % of sales)

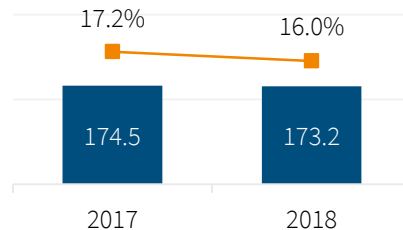

- Material costs ratio up by 240 BP and gross profit down by 130 BP due to increased raw material prices caused by cost inflation, forces majeures and steel tariffs.
- Personnel expenses improved by 60 BP mainly due to employee bonus cuts.
- Other operating income and expenses increased by 30 BP due to variable extra costs in the areas of purchasing, production and logistics caused by material shortages.
- As a result adjusted EBITA margin decreased by 120 BP.

Margin Development Adjusted and Reported since IPO

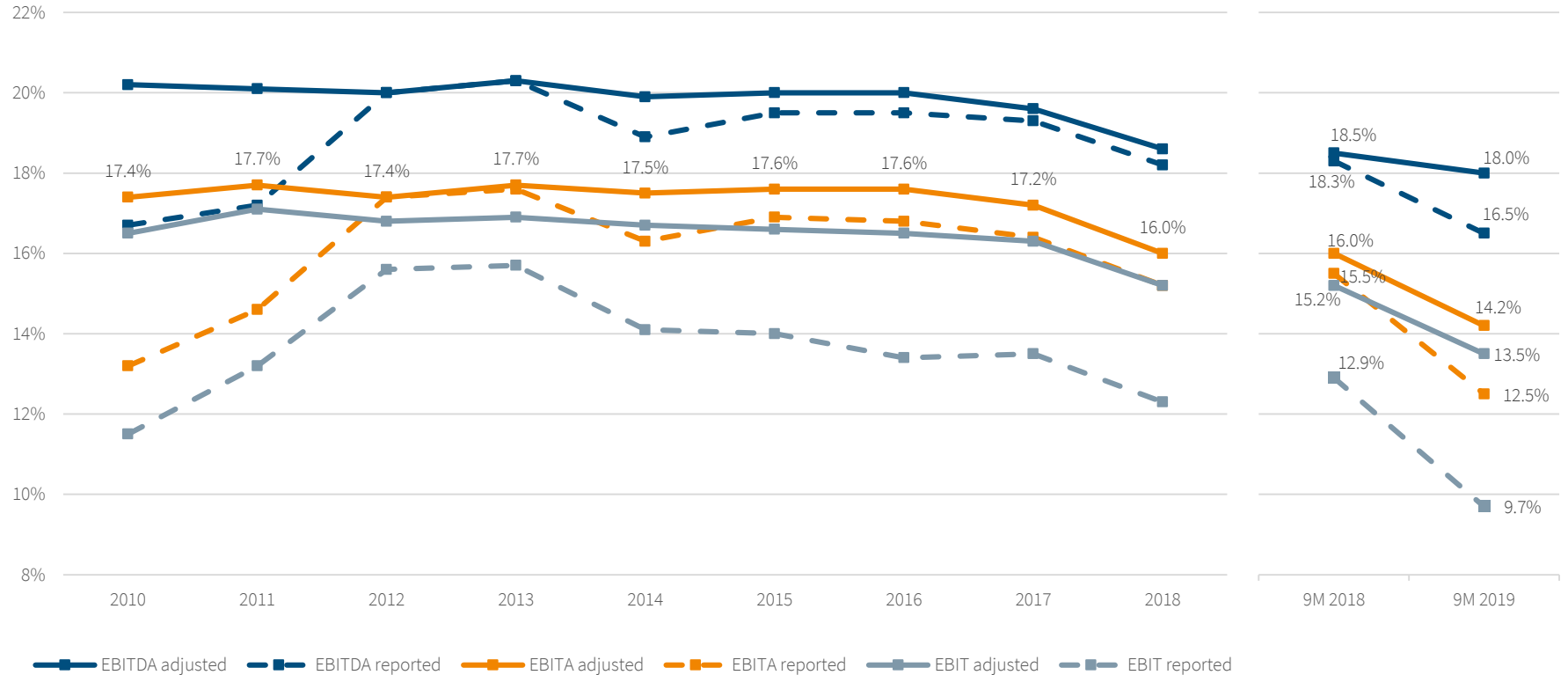

Comparison of Guidance and Actual Results



	Results in 2017*	March 2018	May 2018	July 2018	Results in 2018
Organic Growth of Group Sales	8.6% organic growth, additionally acquisitions EUR 57.3 million	solid organic growth of around 3% to 5%, additionally around EUR 5 million acquisitions	organic growth of around 5% to 8%, additionally around EUR 5 million acquisitions	Solid organic growth of around 5% to 8% aiming to reach the upper end, additionally around EUR 17 million acquisitions	7.7% organic growth, additionally acquisitions EUR 16.5 million
Organic Sales Growth EMEA	6.2% organic growth	Solid organic growth	---	---	2.0%
Organic Sales Growth AM	8.4% organic growth	Solid organic growth	Strong organic growth	---	12.4%
Organic Sales Growth APAC	22.7% organic growth	Double-digit organic growth	Higher than expected double-digit organic growth	---	14.9%
Adjusted EBITA Margin	17.2%	Sustainable at the same level as in previous years of more than 17%	---	Between 16% and 17%	16.0%
Net Operating Cash Flow (in EUR million)	132.9	Around EUR 140 million	---	Around EUR 130 million	124.4
Dividend (in EUR)	1.05	Approx. 30%-35% of adjusted Group Net Profit	---	---	1.10**
Payout ratio (in %)	31.9				30.5

* The adjustments relate to adjustments for acquisitions as well as the initiated rightsizing project announced in February 2019.

** In accordance with the Management Board's proposal for the appropriation of net profit, subject to the approval by the Annual General Meeting on May 21, 2019.

Operational Adjustments on EBIT and EBITA level

- Operational adjustments from the Kimplas and Statek acquisitions of EUR 2.2 million and rightsizing costs of EUR 2.2 million in 2018.

in EUR million	2010	2011	2012	2013	2014	2015	2016	2017	2018
Reported EBITA	64.9	84.7	105.2	112.1	113.3	150.5	150.4	166.8	164.8
+ Acquisition and Rightsizing Costs*	17.5	16.8	0	0	6.9	3.6	4.8	3.5	4.4
+ PPA Depreciation	3.0	1.2	0.3	0.5	1.3	2.2	2.3	4.2	4.0
Total Adjustments	20.5	18.0	0.3	0.5	8.2	5.8	7.1	7.7	8.4
Adjusted EBITA	85.4	102.7	105.4	112.6	121.5	156.3	157.5	174.5	173.2

Reported EBIT	56.3	76.6	94.4	99.5	97.8	124.8	120.0	137.8	133.5
+ Acquisition and Rightsizing Costs*	17.5	16.8	0	0	6.9	3.6	4.8	3.5	4.4
+ PPA Depreciation	3.0	1.2	0.3	0.5	1.3	2.2	2.3	4.2	4.0
+ PPA Amortization	4.0	5.1	7.2	7.7	10.1	17.3	20.6	20.5	22.6
Total Adjustments	24.5	23.1	7.5	8.2	18.3	23.1	27.7	28.2	31.0
Adjusted EBIT	80.9	99.7	101.9	107.7	116.2	147.9	147.7	166.0	164.5

* 2010-2011: mostly IPO related costs

Outlook on Adjustments 2019 – 2020



in EUR million	FY 2018	FY 2019*	FY 2020*
EBITDA level	4.4 (incl. EUR 0.6 million integration costs & EUR 0.4 million inventory-step-ups, EUR 1.2 million acquisition costs and EUR 2.2 million Rightsizing costs)	ca. 8-13	0
EBITA level	8.4 (incl. EUR 4.0 million depreciation PPA)	ca. 11-16 (incl. ca. EUR 3 million depreciation PPA)	ca. 3 (depreciation PPA)
EBIT level	30.9 (incl. EUR 22.6 million amortization PPA)	ca. 33-38 (incl. ca. EUR 22 million amortization PPA)	ca. 25 (incl. ca. EUR 22 million amortization PPA)
Net Profit	23.0 (incl. EUR -7.9 million post tax impact)	ca. 25-28	ca. 19
EPS (in EUR)	0.73	ca. 0.77-0.89	ca. 0.58

* depending on foreign exchange rates

EPS – Dividend Proposal of EUR 1.10 per Share

- Dividend proposal to the shareholders at the AGM on May 21, 2019: EUR 1.10 per share (2018: EUR 1.05).
- Pay-out of EUR 35.0 million for 31,862,400 shares (30.5% of adjusted Group net profit of EUR 114.8 million).
- General policy: dividend of approx. 30% to 35% of adjusted Group net profit.

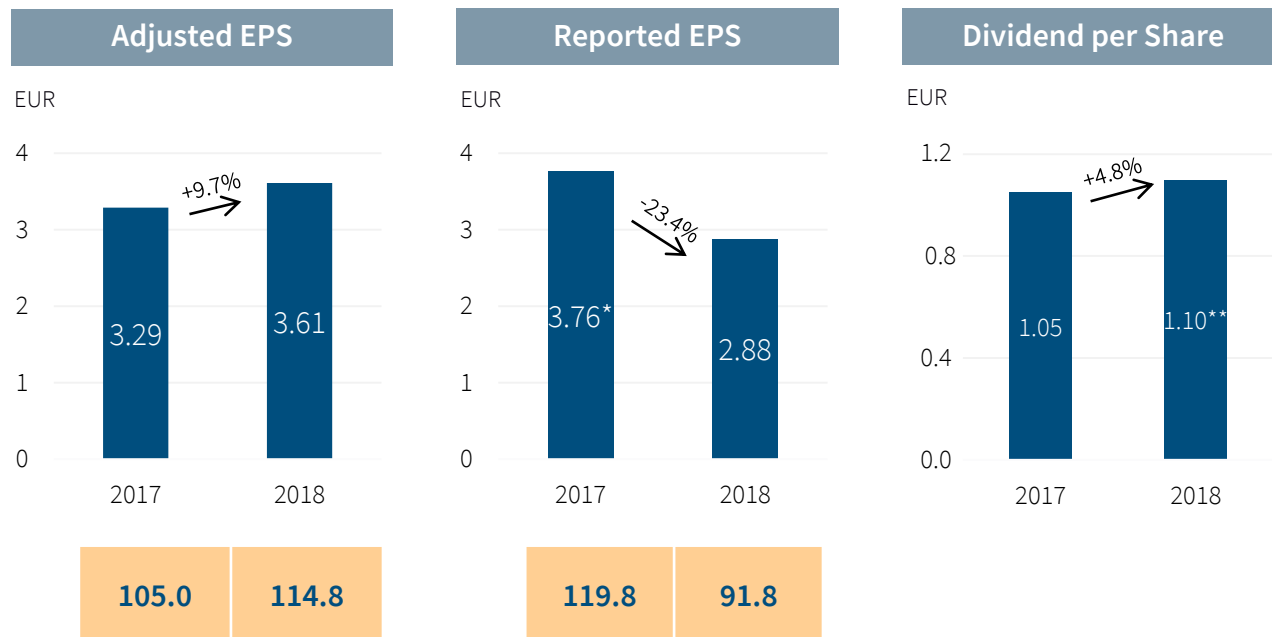

* including positive one-off non cash US tax effect of EUR 1.06 per share

** proposal to the AGM on May 21, 2019

Profit & Loss (adjusted & reported)

in EUR million	Adjusted		Reported	
	2017	2018	2017	2018
Sales	1,017.1	1,084.1	1,017.1	1,084.1
Gross Profit	601.3	626.6	600.2	626.2
EBITDA	199.7	201.4	196.3	197.0
in % of sales	19.6%	18.6%	19.3%	18.2%
EBITA	174.5	173.2	166.8	164.8
in % of sales	17.2%	16.0%	16.4%	15.2%
EBIT	166.0	164.5	137.8	133.5
in % of sales	16.3%	15.2%	13.5%	12.3%
Financial Result	-16.1	-11.7	-16.1	-11.7
Profit before Tax	149.9	152.8	121.7	121.9
Taxes	-44.9	-38.0	-1.9	-30.1
in % of profit before tax	30.0%	24.9%	1.6%	24.7%
Net Profit	105.0	114.8	119.8	91.8

Working Capital Development

Working capital incl. (Reverse-) Factoring and ABS programs

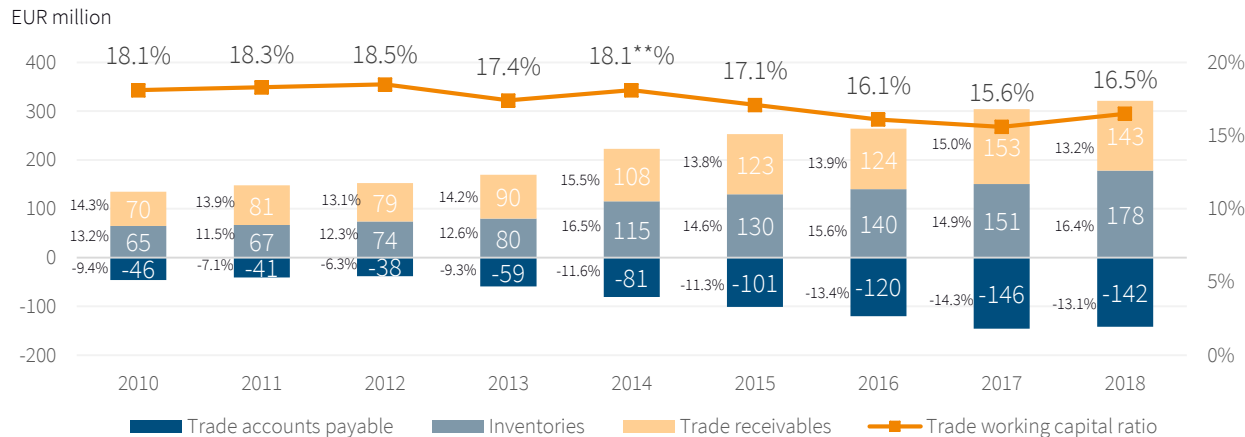

- Increase in working capital to sales ratio in 2018 due to challenging environment in supplies and consequently production and inventories.
- Increase of 330 BP to 23.9% working capital to sales ratio was successfully decreased to 90 BP or 16.5% due to Factoring and ABS programs.

Factoring Programs*

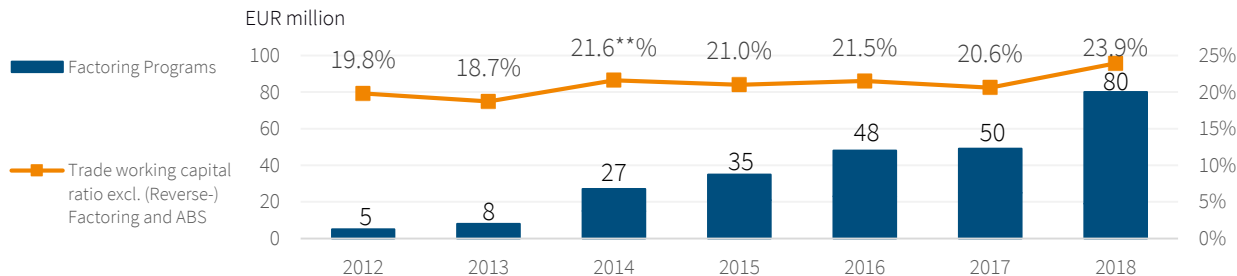

* (Reverse-) Factoring and ABS programs

** in % of sales runrate of EUR 784 million including NDS sales on full year 2014 basis

Equity Ratio on Strong Level of 40.9%

- Equity increased by EUR 68 million with strong profit of EUR 92 million.
- Equity ratio flat despite dividend payment and higher balance sheet total caused by acquisitions.

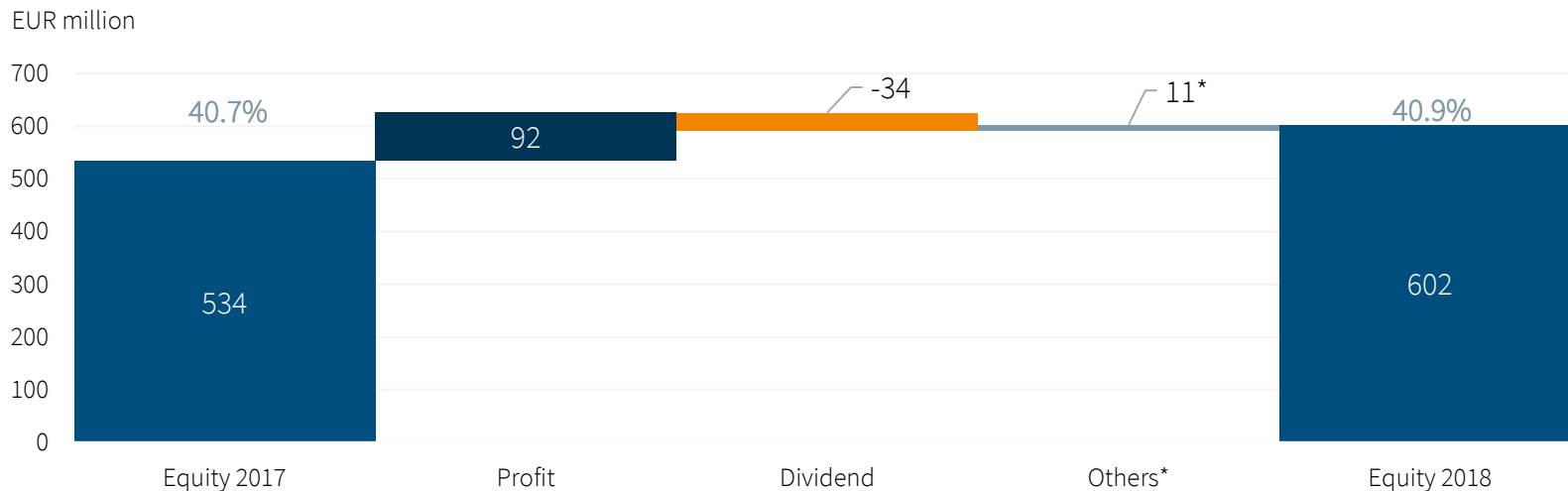

Balance Sheet Total (in EUR million)

1,312

1,472

* mainly exchange differences on translation of foreign operations of EUR 10 million

Net Debt and Net Debt Ratios

- Leverage increases to 1.9 (2017: 1.7) and net debt increases by 16.3% to EUR 400 million including dividend payment of EUR 34 million and the acquisition payment for Kimplas and Statek.

Net Debt* (in EUR million)

in EUR million

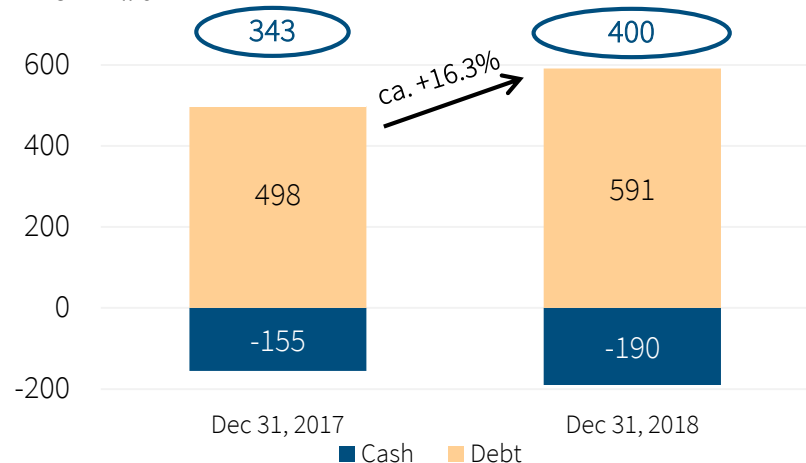

Debt Ratios

	Dec 31, 2017	Dec 31, 2018
Leverage* (Net debt / adjusted EBITDA)	1.7 x	1.9 x
Gearing (Net debt / equity)	0.6 x	0.7 x

* EBITDA includes full year from Kimplas and Statek

Solid Maturity Profile



Maturity Profile (in EUR million) – Financial Instruments

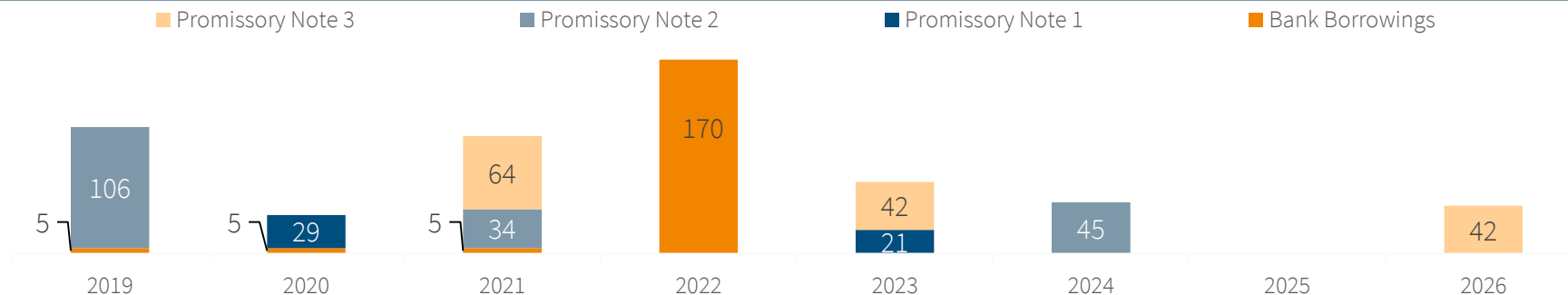

Maturity Profile (in EUR million) – Currencies

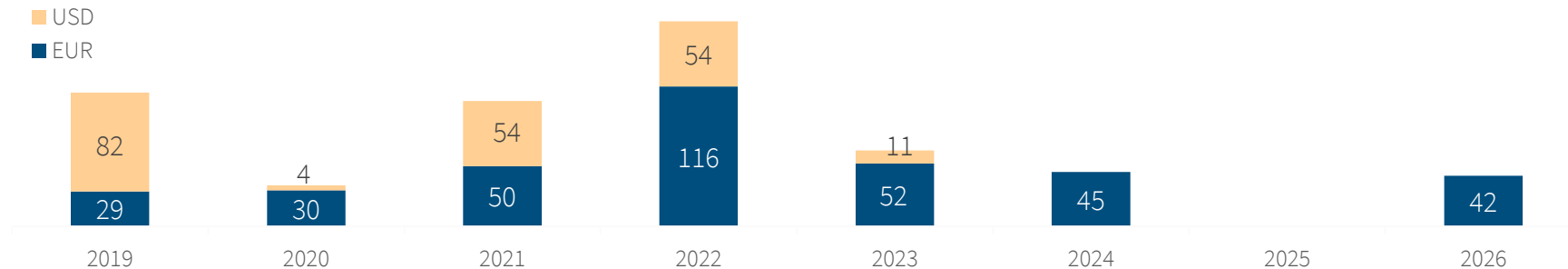

Balance Sheet Total increased mainly due to Acquisitions

in EUR million	Dec 31, 2017	Dec 31, 2018	in EUR million	Dec 31, 2017	Dec 31, 2018
Assets			Equity and liabilities		
Non-current assets			Equity		
Goodwill / Other intangible assets / Property, plant & equipment	817.6	916.2	Total equity	534.3	602.4
Other non-financial assets / Derivative financial assets / Deferred- and income tax assets	7.9	11.2	Non-current and current liabilities		
Total non-current assets	825.5	928.3	Retirement benefit obligations / Provisions	30.9	28.8
Current assets			Borrowings and other financial liabilities	498.8	590.0
Inventories	151.2	178.1	Other non-financial liabilities	32.3	27.4
Other non-financial / other financial / derivative financial / income tax assets	27.3	30.6	Tax liabilities and derivative financial liabilities	69.9	80.4
Trade and other receivables	152.7	143.1	Trade payables	145.7	142.0
Cash and cash equivalents	155.3	190.4	Total liabilities	777.7	869.2
Total current assets	486.6	543.4	Total equity and liabilities	1,312.0	1,471.7
Total assets	1,312.0	1,471.7			

Cash Flow Development 2011 - 2018



Net Operating Cash Flow

in EUR million	2011	2012	2013	2014	2015	2016	2017	2018	Variance (2018 to 2017)
Adjusted EBITDA	117.0	120.8	129.3	138.4	177.5	179.4	199.7	201.4	+0.9%
Δ ± Trade Working capital	-19.5	-9.8	+5.1	+10.4	-0.6	+17.0	-19.1	-13.7	-28.3%
Net operating cash flow before investments from operating business	97.5	111.0	134.4	148.8	176.9	196.4	180.6	187.7	+3.9%
Δ ± Investments from operating business	-30.7	-30.0	-30.5	-39.6	-42.2	-47.9	-47.7	-63.3	+32.7%
Net Operating Cash Flow	66.8	81.0	103.9	109.2	134.7	148.5	132.9	124.4	-6.4%

- Due to favorable adjusted EBITDA and less outflow of working capital, net operating cash flow before investments from operating business increased by EUR 7.1 million to a total of EUR 187.7 million in 2018.
- CAPEX spendings of EUR 63.3 million mainly for manufacturing facilities in Germany, Poland, Serbia, China, the US and Mexico and the opening of new production sites.
- Net operating cash flow of EUR 124.4 million ensures dividend payment and gives flexibility for further acquisitions.

Continuation of Growth Track and Sustainable Margin in 2018



Revenue (in EUR million)

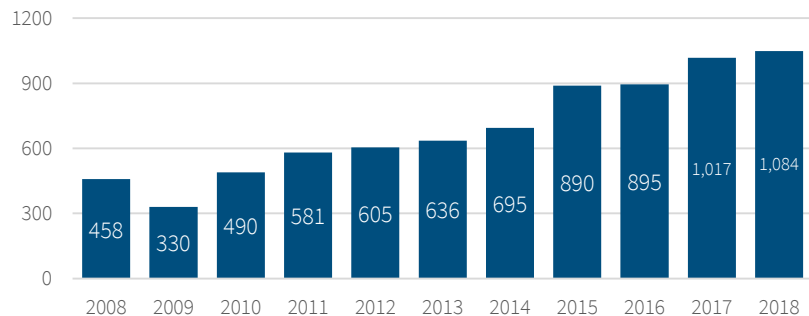

Gross Profit (in EUR million)

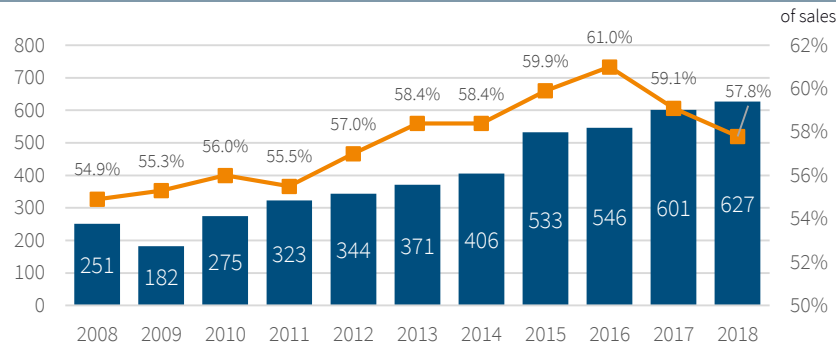

Personnel Expenses (in EUR million)

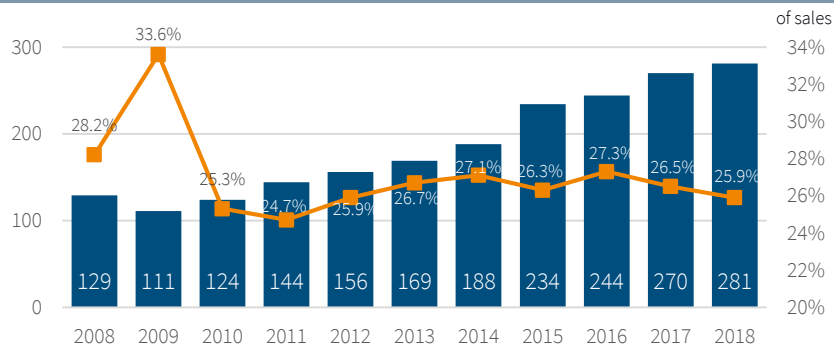

Adjusted EBITA (in EUR million)

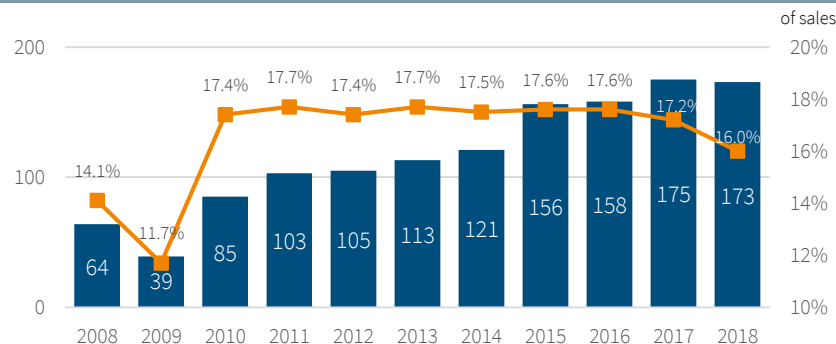

Pro-active Cash Management Continued in 2018

Net Operating Cash Flow (in EUR million)

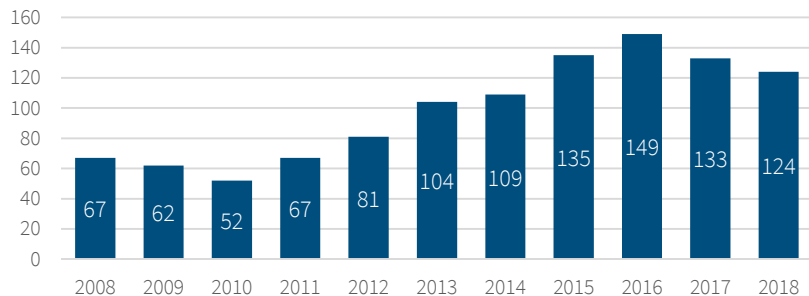

CAPEX (in EUR million)

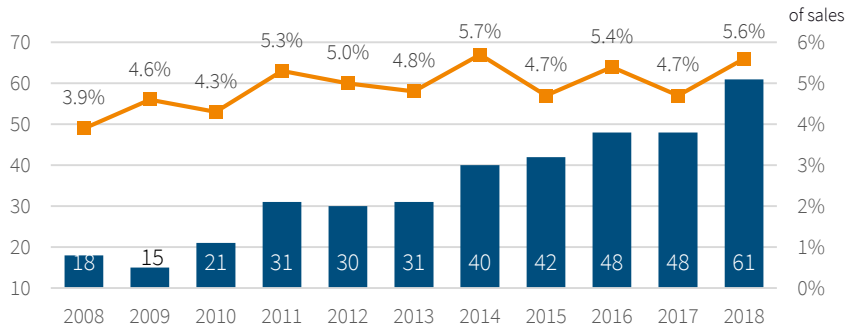

Trade Working Capital (in EUR million)

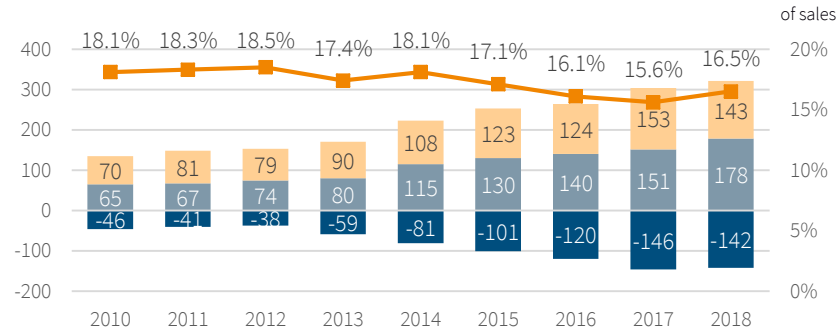

Trade accounts payable Inventories Trade receivables Trade working capital

Longterm Dividend Policy: approx. 30% to 35% of adj. Net Profit of the Period



Dividend in EUR

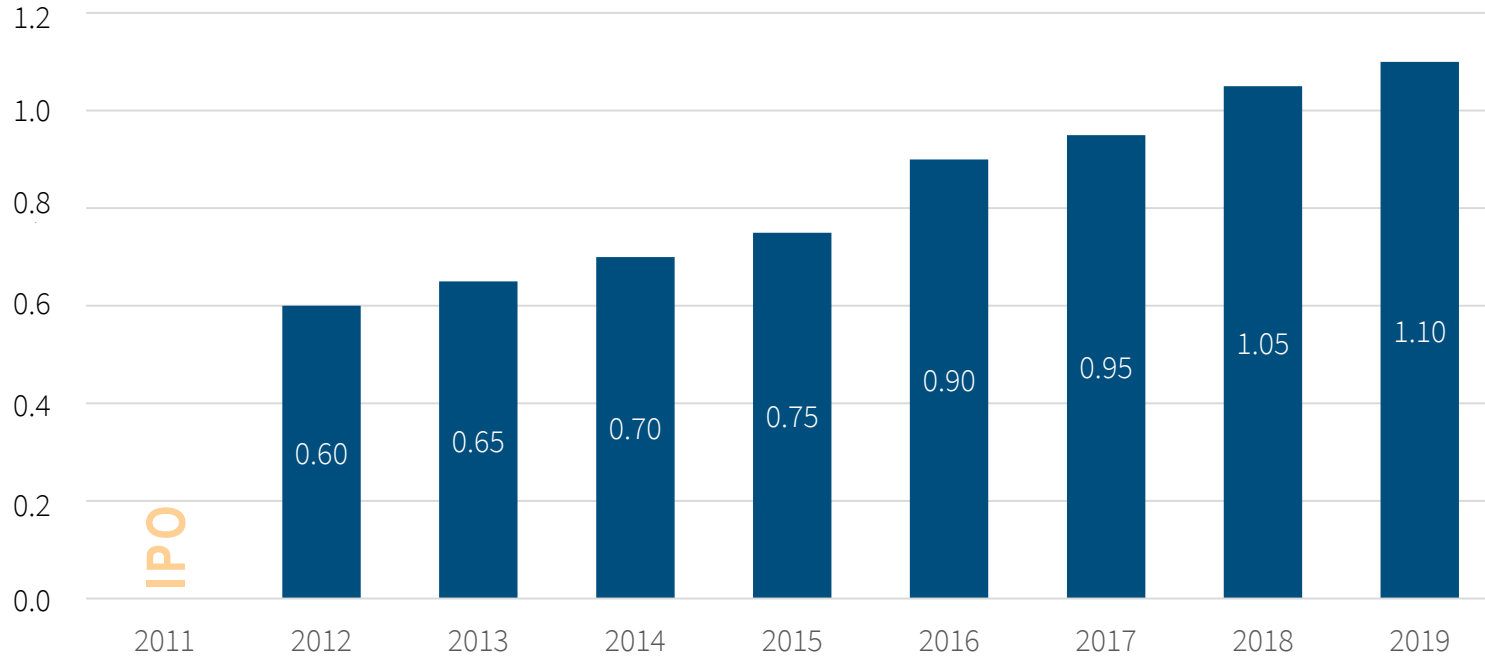

Longterm solid Debt, Leverage and Gearing

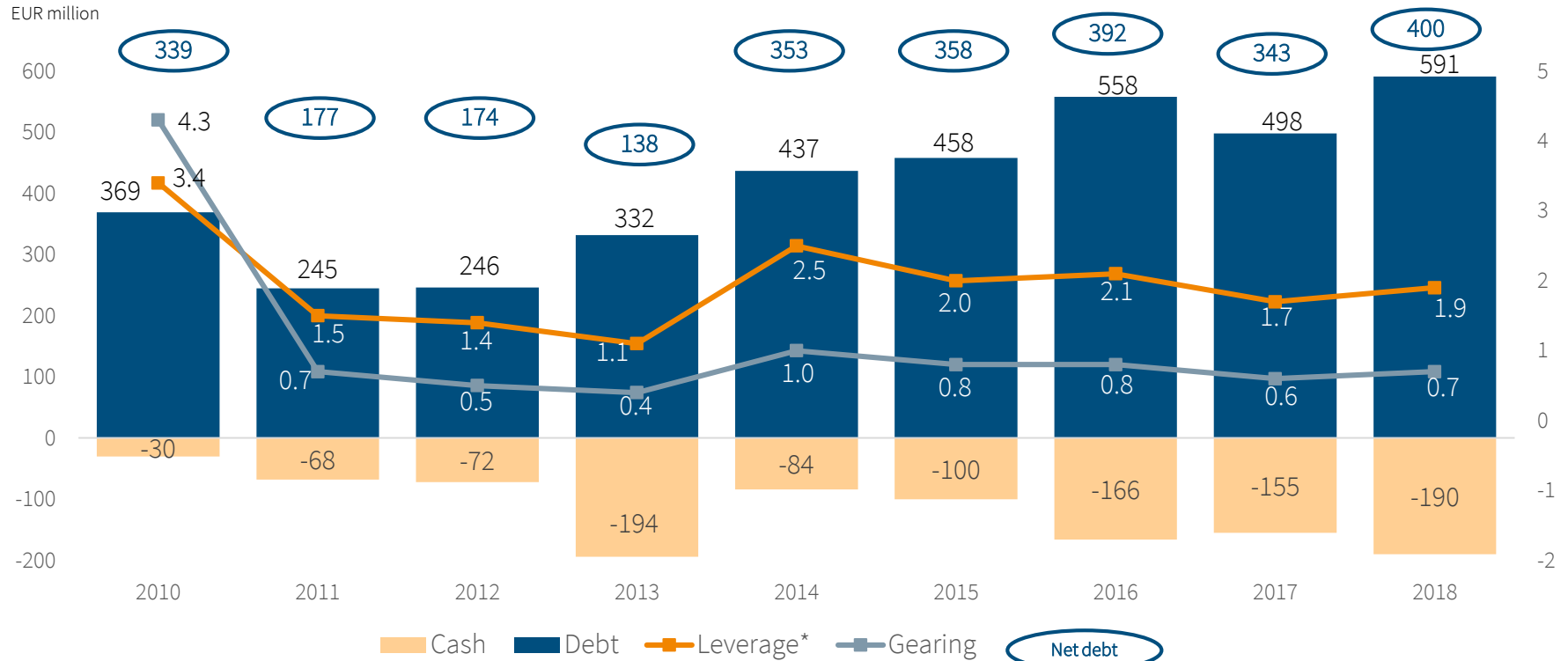

* Leverage: Net debt / adj. EBITDA (incl. 12 months acquisition effects)

Current Shareholder Structure



Identified Institutional Shareholders¹

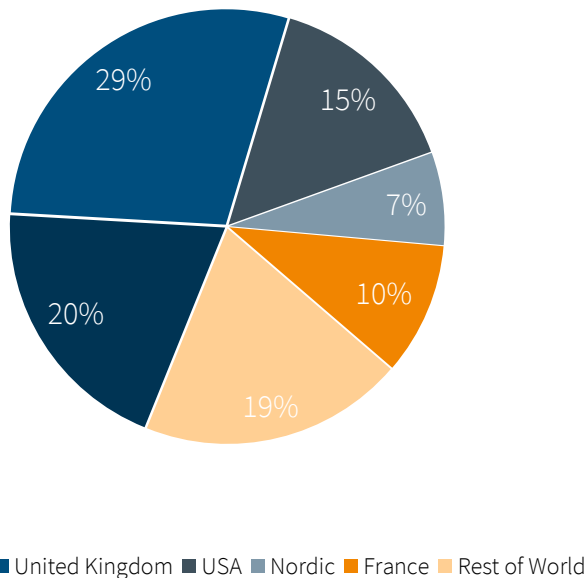

Free Float as of August 5, 2019 includes ²

Allianz Global Investors GmbH, Frankfurt am Main, Germany	14.99%
thereof Allianz Global Investors Fund SICAV, Senningerberg, Luxembourg	3.30%
thereof Allianz SE	3.04%
Ameriprise Financial Inc., Wilmington, DE, USA ³	8.35%
thereof Threadneedle (Lux), Bertrange, Luxembourg	5.004%
Impax Asset Management Group Plc, London, United Kingdom	5.08%
Mondrian Investment Partners Limited, London, United Kingdom	3.10%
BNP Paribas Asset Management S.A., Paris, France	4.91%

¹ As of September 30, 2019.

² According to voting rights notifications. All voting rights notifications are published on the Company's Website (<https://www.normagroup.com/corp/en/investors/>).

Share Price Performance compared with SDAX, MDAX and DAX*

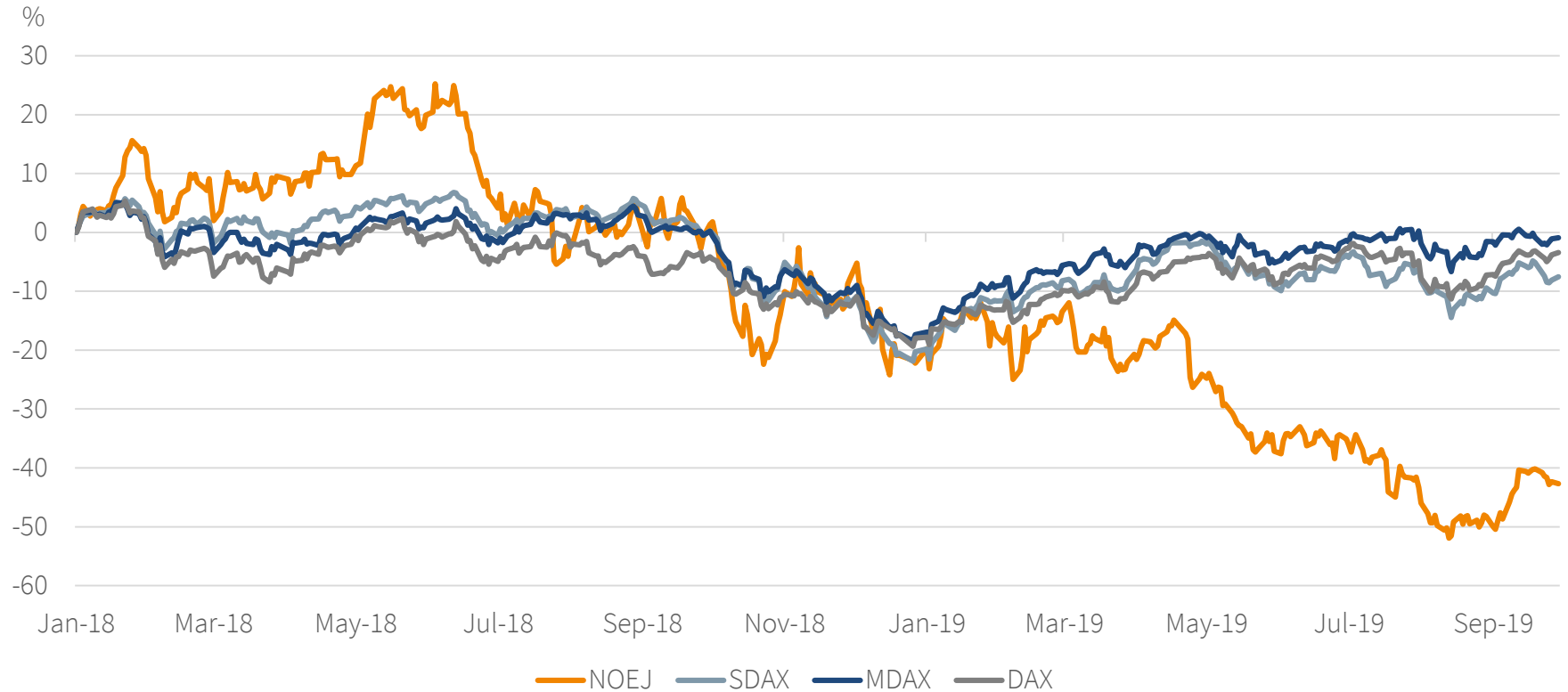

* Index-based; chart data until September 30, 2019

Contact & Event Calendar



Event	Date
Publication Interim Results FY 2019	February 12, 2020
Publication Annual Financial Report 2019	March 25, 2020
Publication Results Q1 2020	May 6, 2020
Publication Results Q2 2020	August 5, 2020
Publication Results Q3 2020	November 4, 2020

Contact

Andreas Troesch

Vice President Investor Relations

Phone: +49 6181 6102-741

Fax: +49 6181 6102-7641

E-mail: Andreas.Troesch@normagroup.com

Internet: <https://investors.normagroup.com/>

Disclaimer



This presentation contains certain future-oriented statements. Future-oriented statements include all statements which do not relate to historical facts and events and contain future-oriented expressions such as ‘believe,’ ‘estimate,’ ‘assume,’ ‘expect,’ ‘forecast,’ ‘intend,’ ‘could’ or ‘should’ or expressions of a similar kind. Such future-oriented statements are subject to risks and uncertainties since they relate to future events and are based on the company’s current assumptions, which may not in the future take place or be fulfilled as expected.

The company points out that such future-oriented statements provide no guarantee for the future and that actual events including the financial position and profitability of NORMA Group SE and developments in the economic and regulatory fundamentals may vary substantially (particularly on the down side) from those explicitly or implicitly assumed or described in these statements.

Even if the actual results for NORMA Group SE, including its financial position and profitability and the economic and regulatory fundamentals, are in accordance with such future-oriented statements in this presentation, no guarantee can be given that this will continue to be the case in the future.

Non audited data is based on management information systems and/or publicly available information. Both sources of data are for illustrative purposes only.