

# NORMA Group SE

**Third Quarter Results 2018**

---

Maintal, November 7, 2018

# Highlights Q3 2018



## Sales

Up by 9.7 % to EUR 268.1 million (Q3 2017: EUR 244.4 million)

## Adjusted EBITA

EUR 42.8 million reflecting +0.1% y-o-y (Q3 2017: EUR 42.7 million)

## Margin

Adjusted EBITA margin of 16,0% (Q3 2017: 17.5%); already improved vs. Q2 2018: 15.2%

## Balance Sheet

Equity ratio of 40.1% (Dec 31, 2017: 40.7%); Net debt increased by 33% to EUR 457 million (Dec 31, 2017: EUR 343) million including dividend and acquisition payments

## EPS

Earnings per share increased by 10.3% to EUR 0.66 (Q3 2017: EUR 0.60)  
Adjusted earnings per share increased by 8.8% to EUR 0.83 (Q3 2017: EUR 0.77)

## Guidance 2018

Organic growth of around 5% to 8%, aiming to reach the upper end  
Adjusted EBITA margin guidance adjusted to between 16% and 17%

# Strong Organic Growth in 2018



- Strong organic growth of 9.7% in Q1-3 2018 (Q3 2018: 7.1%) mainly due to an increase of content per unit and global production output of the passenger/commercial vehicle markets as well as a very good development of the water management business in the US
- Acquisitive growth of 1.4% or EUR 10.4 million from Fengfan, Statek and Kimplas
- Negative currency effects in H1 2018 and flat currency development in Q3 2018 led in total to sales decrease of 4.1% mainly resulting from the strong Euro vs. US-Dollar

## Sales Development in EUR million

Sales	2017	2018	Change	Change in %	Thereof organic	Thereof acquisitions	Thereof currency
Q1	254.9	272.6	17.7	6.9%	13.6%	1.0%	-7.7%
Q2	264.1	276.4	12.3	4.6%	8.5%	0,7%	-4.5%
Q3	244.4	268.1	23.7	9.7%	7.1%	2.5%	0.1%
<b>Q1-3</b>	<b>763.4</b>	<b>817.1</b>	<b>53.7</b>	<b>7.0%</b>	<b>9.7%</b>	<b>1.4%</b>	<b>-4.1%</b>

# Sales by Region and by Way-to-Market



- Favourable organic growth in Asia-Pacific as well as acquisitive growth from Fengfan and Kimplas led to increased 13% sales ratio in the region
- Negative currency effects especially in Americas partially counters the positive organic growth and leads to stable 41% of sales
- Strong growth in EJT shifts sales contribution by two percentage points to 64%

Q1-3 2018 (Q1-3 2017) sales breakdown by region

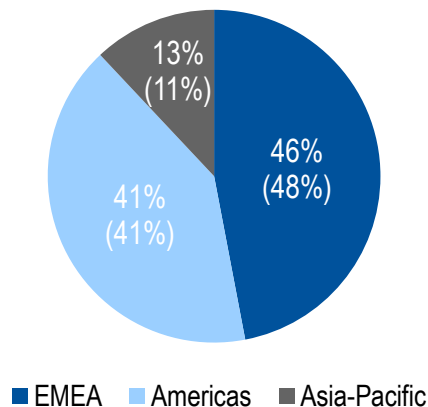

Q1-3 2018 (Q1-3 2017) sales breakdown by way-to-market

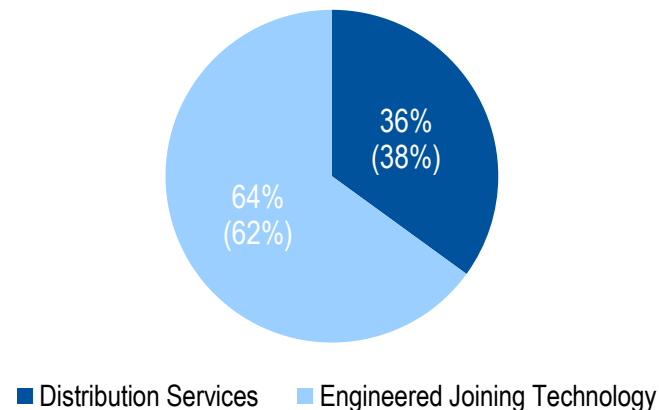

# Profitability Development

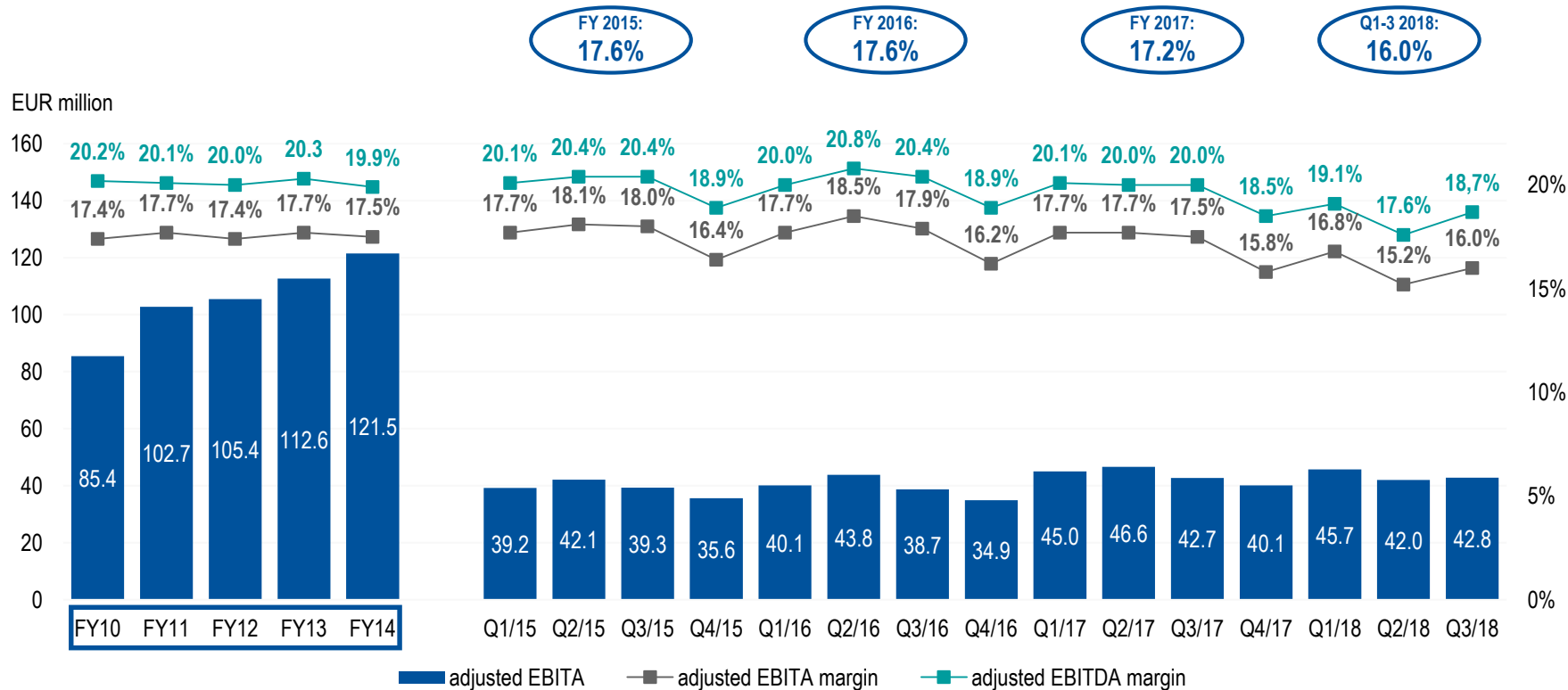

# Adjusted EBITA Mainly Impacted by Critical Raw Material Situation



## (Adjusted) Material Costs (in EUR million and % of sales)

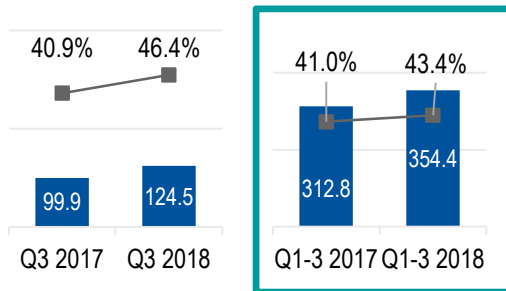

## (Adjusted) Gross Profit (in EUR million and % of sales)

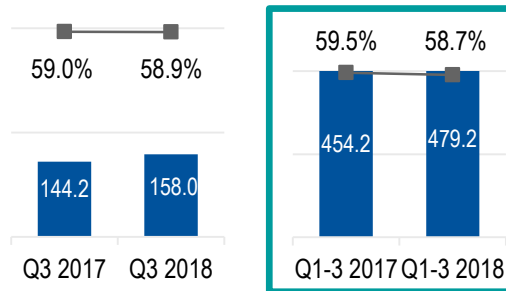

## Adjusted Personnel Expenses (in EUR million and % of sales)

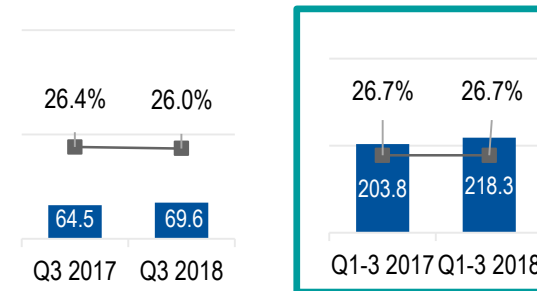

## Adjusted Other OPEX (in EUR million and % of sales)

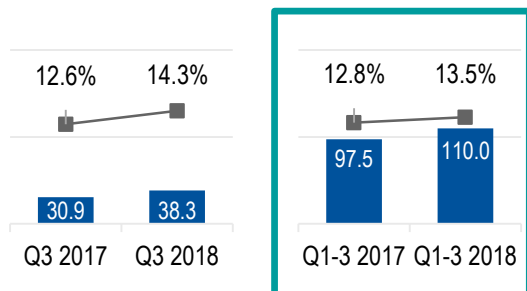

## Adjusted EBITA (in EUR million and % of sales)

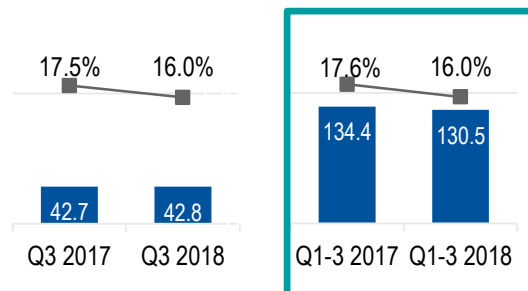

- Stable gross profit in Q3 2018 at 58,9% of sales; YTD at 58,7% still below 2017 (59,5%)
- Main reasons are the increased raw material prices and the increased shortage of material supply as well as the strong sales growth which led to variable extra costs in the areas of purchasing, production and logistics.
- Higher material cost ratio in Q3 2018 due to an increase in inventories of finished goods and work in progress as a result of the volatile environment and production relocations.
- Adjusted EBITA margin sequentially improved from 15.2% in Q2 2018 to 16.0% in Q3 2018

# Adjustments in Q1-3 2018

- Operational adjustments mainly due to the Kimplas acquisition as well as ongoing PPA leads to EUR 0.45 adjustments on EPS level

in EUR million	Reported	Adjustments	Adjusted
Sales	817.1		817.1
EBITDA	149.7	1.3 (acquisition costs)	151.0
<i>EBITDA margin</i>	18.3%		18.5%
EBITA	126.4	4.1 (incl. EUR 2.8 million depreciation PPA)	130.5
<i>EBITA margin</i>	15.5%		16.0%
EBIT	105.0	19.4 (incl. EUR 15.3 million amortization PPA)	124.4
<i>EBIT margin</i>	12.9%		15.2%
Net Profit	68.9	14.5 (post tax impact)	83.4
<i>Net Profit margin</i>	8.4%		10.2%
<b>EPS (in EUR)</b>	<b>2.16</b>	<b>0.45</b>	<b>2.61</b>

Deviations may occur due to commercial rounding.

Full year 2018 adjustments: ca. EUR 1.5 million for Kimplas and Statek; ca. EUR 4 million depreciation PPA; ca. EUR 21 million amortization PPA

# EPS Development in 2018

## Adjusted EPS\*

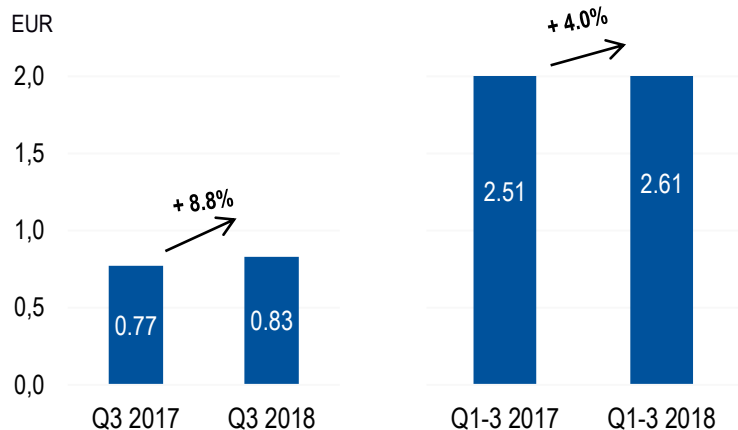

## Reported EPS\*

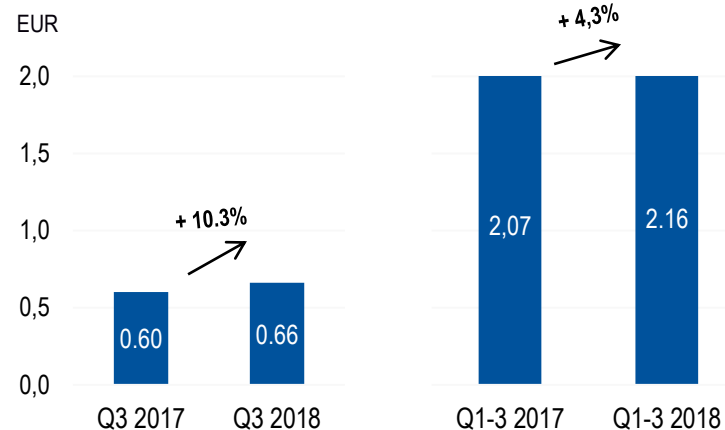

### Net Income in EUR million

Q3 2017	24.4	Q3 2018	26.5
---------	------	---------	------

Q1-3 2017	80.1	Q1-3 2018	83.3
-----------	------	-----------	------

Q3 2017	19.1	Q3 2018	21.0
---------	------	---------	------

Q1-3 2017	66.0	Q1-3 2018	68.8
-----------	------	-----------	------

\* Based on number of shares of 31,862,400



# Net Debt and Financing

- Net debt at EUR 457 million, an increase of 33.0% mainly due to financing of Kimplas and Statek acquisitions as well as dividend payment
- Equity ratio decreased to 40.1% (Dec 31, 2017: 40.7%) due to higher balance sheet total and dividend payment

## Net Debt (in EUR million)

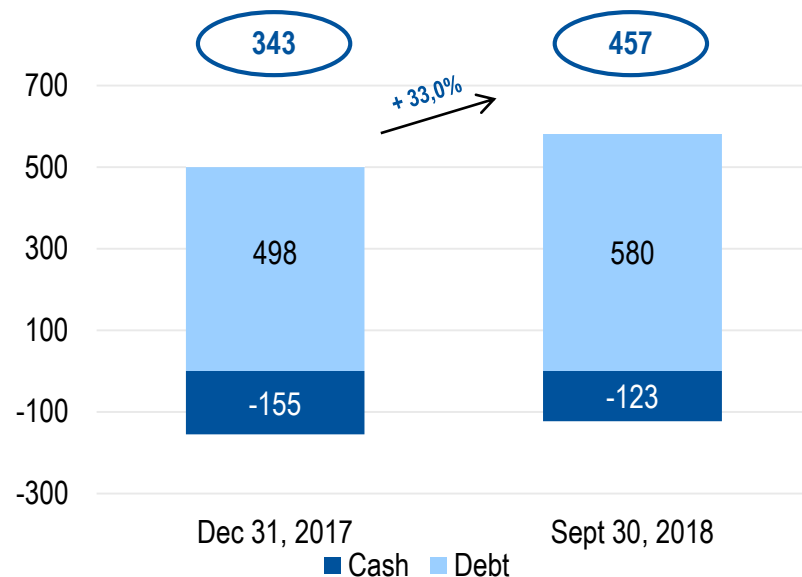

## Equity Ratio

	Dec 31, 2017	Sept 30, 2018
Equity Ratio (equity / balance sheet total)	40.7%	40.1%

## Debt Ratios

	Dec 31, 2017	Sept 30, 2018
Leverage* (Net debt / adjusted LTM EBITDA)	1.7 x	2.2 x
Gearing (Net debt / equity)	0.6 x	0.8 x

\* EBITDA includes full year from Fengfan, Kimplas and Statek

# Net Operating Cash Flow 2018



## Net Operating Cash Flow

in EUR million	Q1-3 2017	Q1-3 2018	Variance	Q3 2017	Q3 2018	Variance
Adjusted EBITDA	152.9	151.0	-1.2%	48.8	50.1	+2.7%
Δ ± Working capital	-50.0	-67.2	+34.4%	-4.5	-9.3	+105.2%
<b>Net operating cash flow before investments from operating business</b>	<b>102.9</b>	<b>83.8</b>	<b>-18.6%</b>	<b>44.2</b>	<b>40.8</b>	<b>-7.8%</b>
Δ ± Investments from operating business	-31.0	-44.4	+43.4%	-12.7	-17.8	+40.0%
<b>Net operating cash flow</b>	<b>72.0</b>	<b>39.4</b>	<b>-45.3%</b>	<b>31.5</b>	<b>23.0</b>	<b>-27.0%</b>

- Working capital outflow due to excellent growth leads to a decrease of net operating cash flow before investments by EUR 19.1 million to a total of EUR 83.8 million
- CAPEX spending at EUR 44.4 million mainly for manufacturing facilities in Germany, Poland, Serbia, China, the US and Mexico

# Outlook 2018 – Company Guidance

---

## Sales

Organic growth of around 5% to 8% aiming to reach the upper end, additionally around EUR 17 million from acquisitions

## Adjusted EBITA Margin

Between 16% and 17%

## Net Operating Cash Flow

EUR 130 Mio.

## Dividend

Approx. 30% to 35% of adjusted net profit of the Group



# Appendix

Strategy

# NORMA Group's Key Facts



## Specific customer requirements driven by megatrends



**Global market** and technology leader in joining and fluid handling technology



Offers more than 40,000 innovative joining solutions in three product categories: **Clamp, Connect, Fluid**



Delivers to more than **10,000 customers** in 100 countries



Employees **> 9,000 worldwide**



Operates a global network of more than **30 manufacturing facilities**



Numerous sales and distribution sites **across Europe, the Americas and Asia-Pacific**



Sales of about **EUR 1,017 million in 2017**

# Proven Business Model Addressing Key Megatrends

## Specific customer requirements driven by megatrends

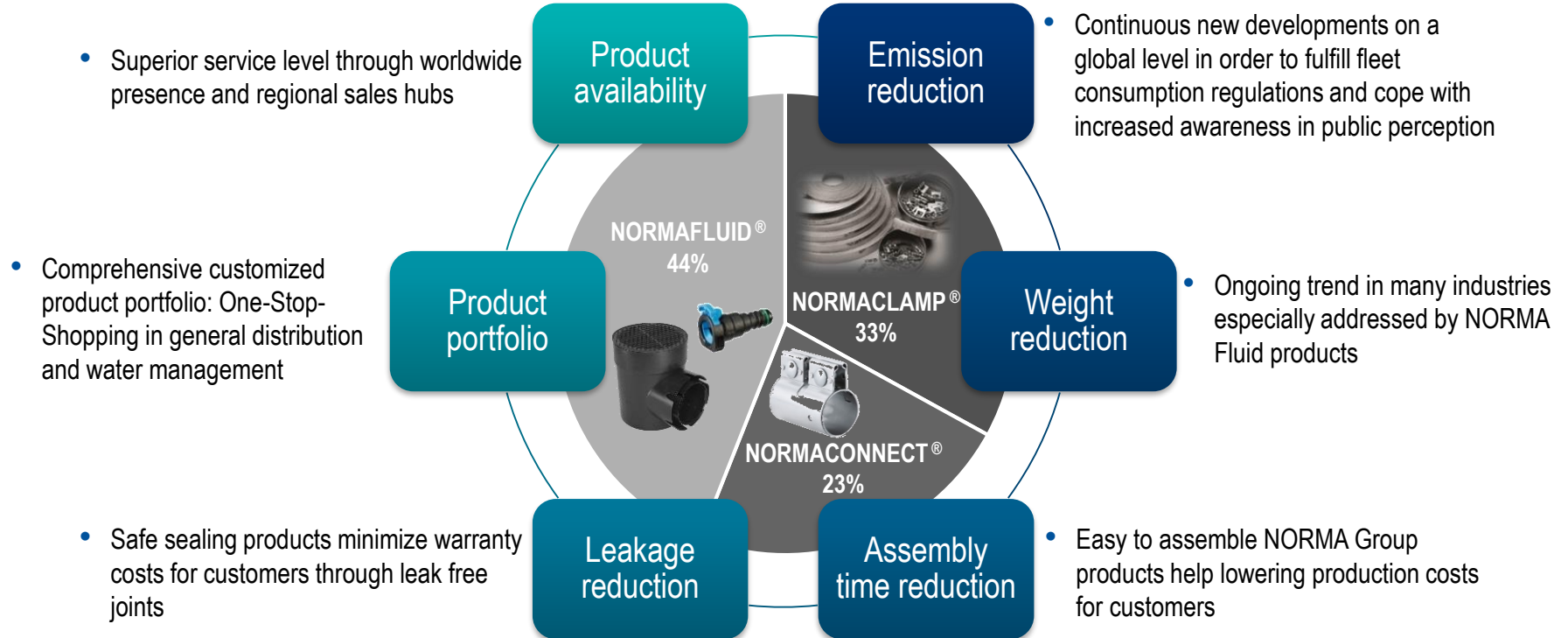

# Tighter Emission Regulations Drive Increased Joining Technology Content

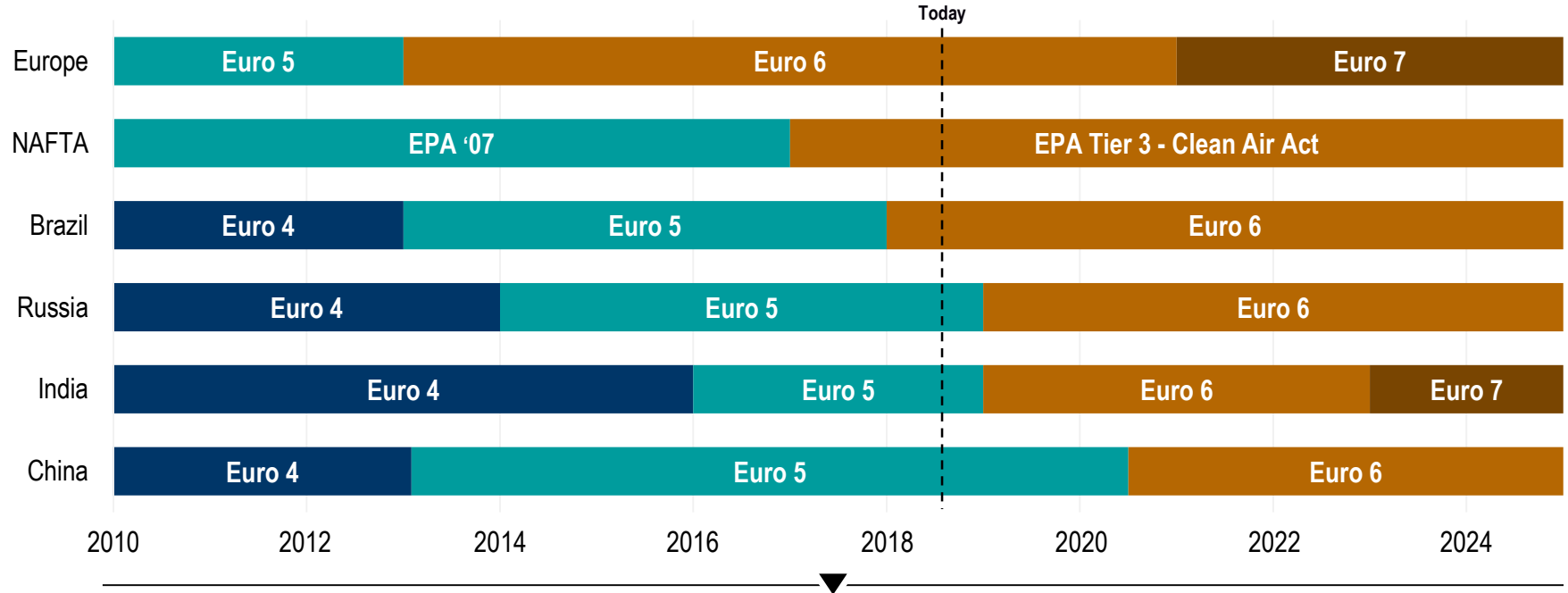

- Environmental awareness continues to drive tightening emission regulations globally, including in emerging markets
- Low-emission alternatives require significantly higher joining technology content at a substantially increased complexity compared to existing/past technologies

# Fleet Efficiency Europe: Innovation Rate must Double

## EU legislation required CO<sub>2</sub> fleet average limits

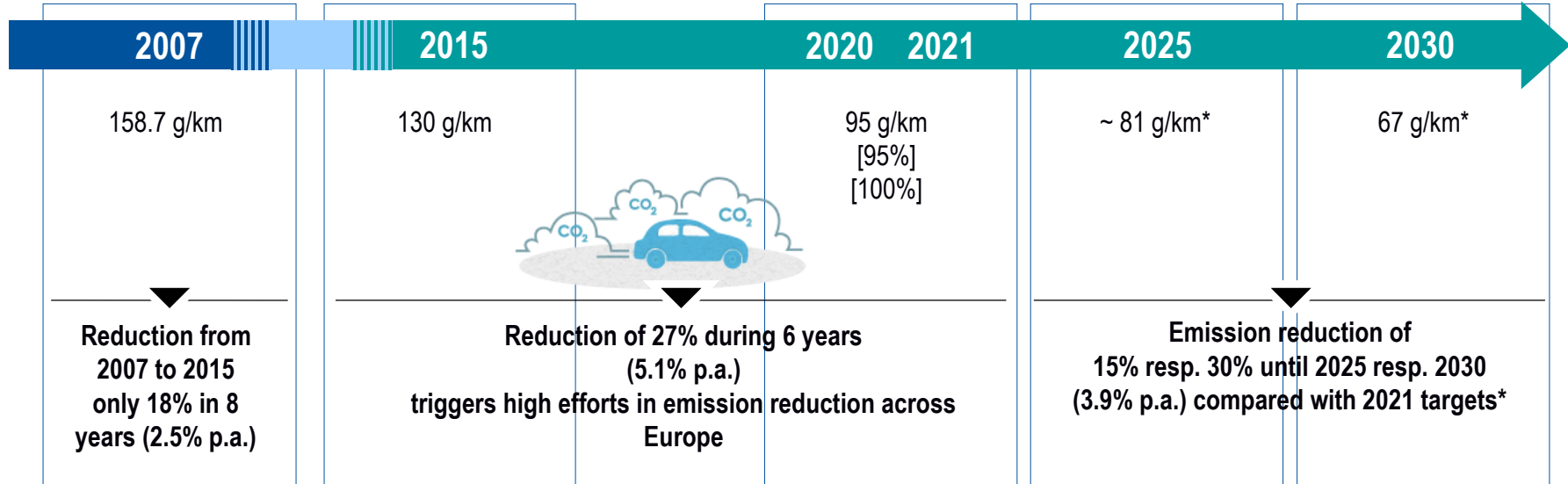

- Low emitting cars (below 50 g/km CO<sub>2</sub>) counted as 1.5 vehicles in 2015
- During second stage from 2020 onwards low-emitting cars will be counted as 2 (1.67) in 2020 (2021)



# Innovation Rates\*



## Global Comparison of Fuel Economy

Region	Target year 1	Target year 2	Duration in years	Fleet Goal Year 1		Fleet Goal Year 2		Change	CAGR
				under national laws	converted**	under national laws	converted**		
				EU	2015	2021	6		
USA	2016	2025	9	37.8 mpg	139 g/km	56.2 mpg	88 g/km	-37%	-5.0%
China	2015	2020	5	6.9 l/100km	161 g/km	5.0 l/100km	117 g/km	-27%	-6.2%
Japan	2015	2020	5	16.8 km/l	139 g/km	20.3 km/l	115 g/km	-17%	-3.7%
India	2016	2021	5	130 g/km	130 g/km	113 g/km	113 g/km	-13%	-2.8%

\* Chart shows emission regulation roadmap for passenger vehicles adapted to the consumption of gasoline engines (Source: European Commission, ICCT, NORMA Group)



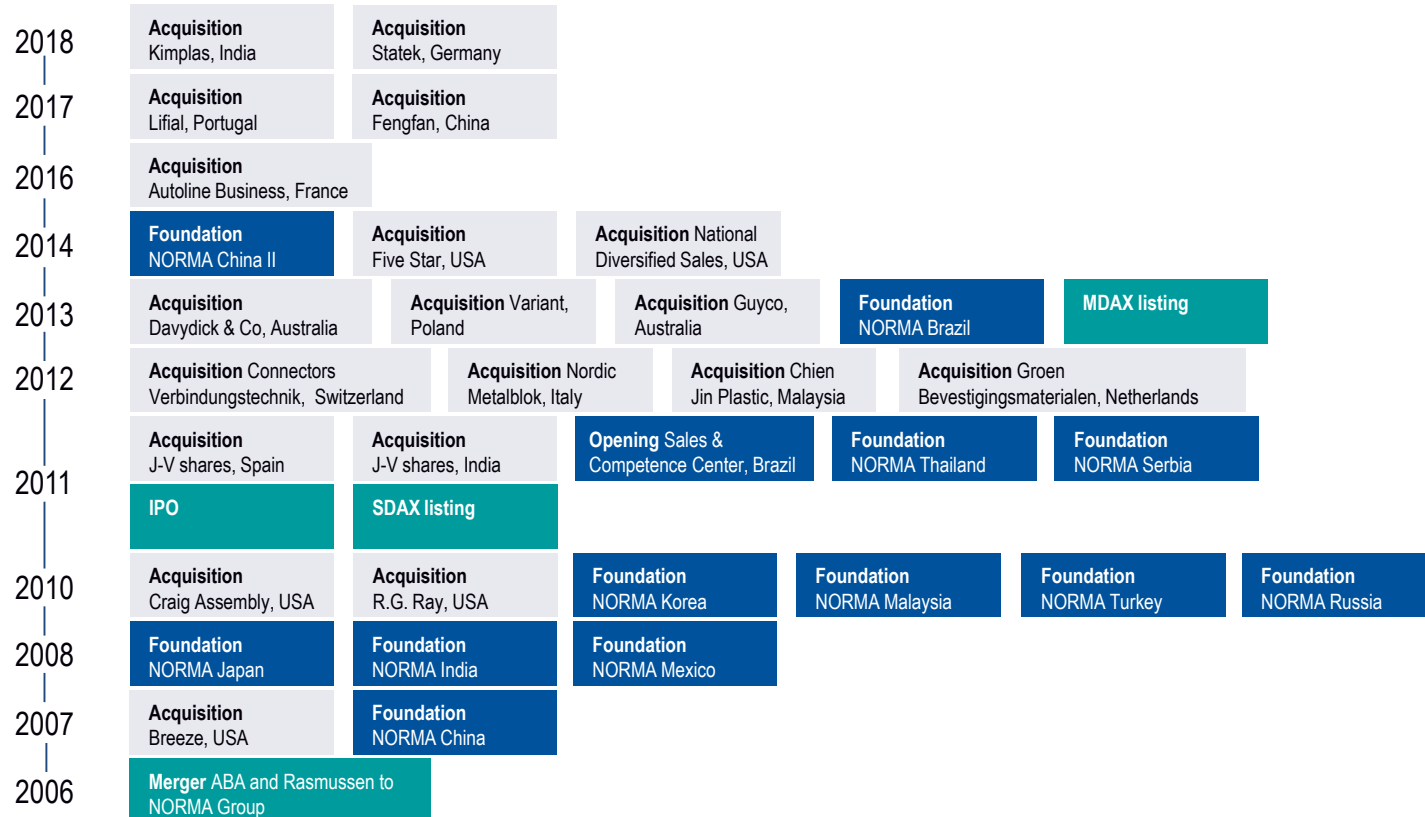

\*\* Fuel economic data is normalized as g CO<sub>2</sub>/km in accordance with the NEDC

# History of Excellence



# NORMA Group well on Track for Coming E-Mobility Developments



-  Battery Thermal Management
-  Coolant Systems
-  Power Electronics and Motors Cooling
-  HVAC / Heat Pump Systems

## NORMA Group will benefit from a graduated hybridization

### ICE, Hybrid & EV development\*

Production volume in million

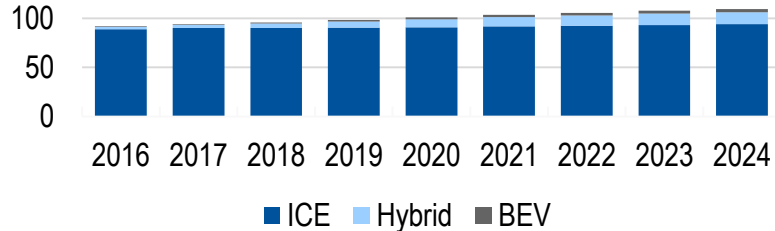

## Content per engine type

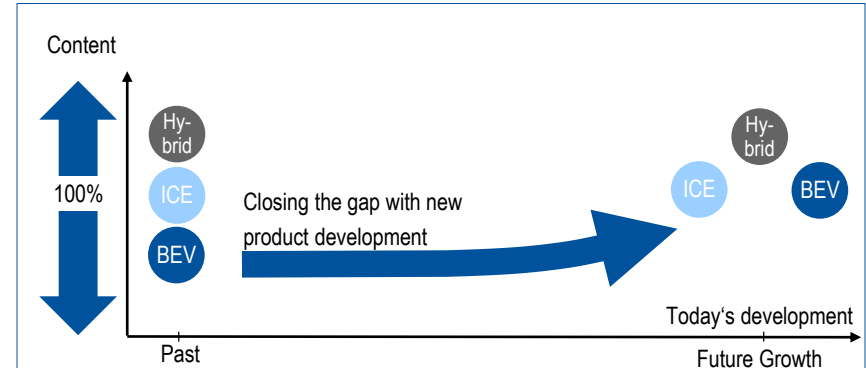

\*Source: LMC

# Future Developments in Content per Vehicle

## Battery Electric Vehicle

- Exhaust system and combustion engine parts being replaced with new business opportunities for thermal management and other components

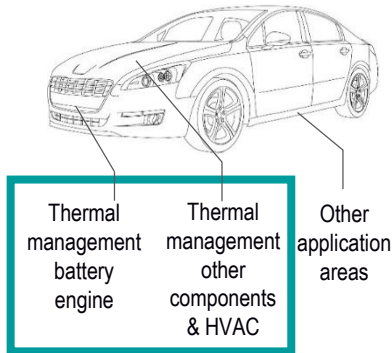

New Business

## Hybrid Gasoline

- Additional products e.g. for thermal management

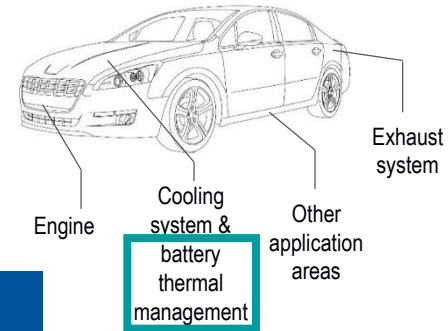

New Business

## Internal Combustion Engine (Gasoline & Diesel)

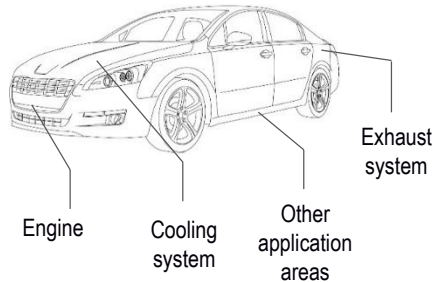

# 14 Acquisitions since the IPO in 2011 representing 46% of Sales in 2011



Sales Consolidation Effects (in EUR million)	Date of Acquisition		Total Sales
CONNECTORS Verbindungstechnik AG, Switzerland	04/12	Market entry in connecting technology in Pharma & Biotech	16.6
Nordic Metalblok S.r.l., Italy	07/12	Market consolidation heating and air conditioning clamps	5.2
Chien Jin Plastic Sdn. Bhd., Malaysia	11/12	Market entry joining elements for water distribution	7.7
Groen Bevestigingsmaterialen B.V., Netherlands	12/12	Securing market with national dealer	3.4
Davydick & Co. Pty. Limited, Australia	01/13	Enforce market position with distribution of water & irrigation systems	3.4
Variant SA, Poland	06/13	Securing market with national dealer	2.3
Guyco Pty. Limited, Australia	07/13	Enforce market position with distribution of water & irrigation systems	7.2
Five Star Clamps Inc., USA	05/14	Consolidation of multi industrial engineered clamps	4.0
National Diversified Sales, Inc., USA	10/14	Expanding water management product portfolio	129.3
Autoline, France	12/16	Expanding product portfolio and strengthening market position in the area of quick connectors	46.2
Lifal - Indústria Metalúrgica de Águeda, Lda., Portugal	01/17	Strengthening product portfolio of DS business and market consolidation	7.4
Fengfan Fastener (Shaoxing) Co., Ltd., China	05/17	Expanding product portfolio and market position	11.5
Kimplas Piping Systems Ltd., India	07/18	Expanding water management product portfolio	21.0
Statek Stanzereitechnik GmbH, Germany	08/18	Expanding value chain for stamping and forming technology	5.0
<b>Total</b>			<b>270.2</b>

# Acquisition of the Autoline business from Parker Hannifin



## M&A

Acquisition of all assets of the Autoline business from Parker Hannifin in November 2016

## Business Model

Global supplier of quick connectors for all types of automotive fluid line applications  
Based in Guichen, France, with production sites in France, Mexico and China

## History

For more than 20 years the company has been designing, manufacturing and marketing quick connectors for fuel lines, cooling lines, vapor lines, braking assistance lines and SCR (Selective Catalytic Reduction) circuit lines

## Sales

Sales of around EUR 40 million in financial year 2016 (Jul 1, 2015 – Jun 30, 2016)

## Consolidation

First time consolidation into NORMA Group started December 2016

## Margin

In the range of NORMA Group's margin

## Financing

Transaction was financed with credit facilities

# Acquisition of Lifial

---

## M&A

Acquisition of Lifial – Indústria Metalúrgica de Águeda, Lda. ('Lifial'), Portugal, in January 2017

## Business Model

Manufacturer of metal clamps for the use in industry and agriculture (distribution business)  
Based in Águeda, Portugal

## History

For more than 28 years the company has been manufacturing heavy duty clamps, pipe supporting clamps, and U-bolt clamps for mounting antennas and solar modules and has been selling them to customers in Europe and North Africa

## Sales

Sales of around EUR 8 million in financial year 2015  
(thereof approx. EUR 1 million sales directly with NORMA Group)

## Consolidation

First time consolidation into NORMA Group started January 2017

## Margin

In the range of NORMA Group's margin

## Adjustments

No operational adjustments planned from acquisition

# Acquisition of Fengfan

---

## M&A

Acquisition of 80% of Fengfan Fastener (Shaoxing) Co., Ltd. ('Fengfan'), China

## Business Model

Manufacturer of joining products made of stainless steel, nylon and specialty materials  
Based in Shaoxing City, China

## History

Founded in 1988, the company has been manufacturing cable ties, fastening elements and specially coated, fire-resistant textiles and has been selling them to customers in the shipbuilding and heavy industries as well as to manufacturers of transport vehicles mainly in China

## Sales

Sales of around EUR 15 million in financial year 2016

## Consolidation

First time consolidation into NORMA Group started May 2017

## Margin

In the range of NORMA Group's margin

## Adjustments

No operational adjustments planned from acquisition



# Acquisition of Kimplas Piping Systems Ltd.

---

## M&A

Signing of Kimplas Piping Systems Ltd. India in April 2018

## Business Model

Leading Indian manufacturer of joining technology made of thermoplastic materials  
Based in Nashik, India with own production site

## History

Since 1996 the company has been developing and manufacturing injection-molded parts used to ensure safe and leakage free supply of drinking water and gas to rural and urban households and provide filtered water for micro irrigation systems.

## Sales

Sales of around EUR 21 million in financial year 2018 (Apr 1, 2017 – Mar 31, 2018)

## Consolidation

First time consolidation into NORMA Group started July 2018

## Margin

In the range of NORMA Group's margin

## Financing

Transaction was financed with credit facilities

# Acquisition of Statek Stanzereitechnik GmbH

---

## M&A

Signing of Statek Stanzereitechnik GmbH, Maintal, Germany, in June 2018

## Business Model

Producer of contact and stamped parts, housings, wave springs and other products for electrical engineering and industry purposes

## History

Founded in 1980, Statek has many years of experience and a high level of production expertise in stamping, bending and forming technology for almost all commonly used metals

## Sales

Sales of around EUR 17 million in financial year 2017, thereof around EUR 5 million of external sales

## Consolidation

First time consolidation into NORMA Group started August 2018

## Margin

In the range of NORMA Group's margin

## Financing

Transaction was financed with credit facilities

# NDS Provides Full Breadth of Water Management Solutions



Broad diversification in terms of application areas and products

Stormwater  
Management  
ca. 55%

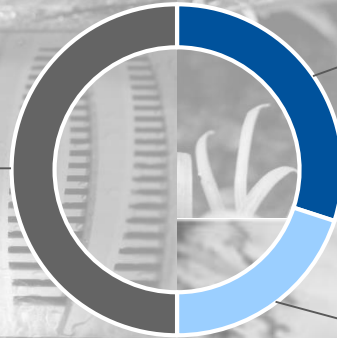

Efficient  
Landscape  
Irrigation  
ca. 27%

Flow Management  
and Others ca. 18%



Large target markets for all NDS application areas nationwide and international

International expansion with mid-term focus

# NDS Has Deep and Longstanding Customer Relationships



## Highly differentiated distribution and service model

- More than 4,300 products
- Over 7,500 customer locations (retail and wholesale customers)
- Two production sites (CA), six warehouses in the US, more than 500 employees
- Overnight shipment for wholesale orders
- 98% on-time delivery

## Over 7,500 customer locations

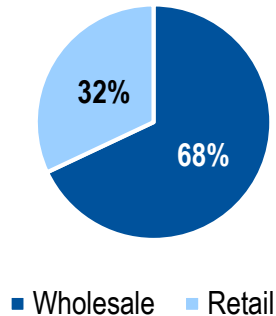

## Nation-wide presence

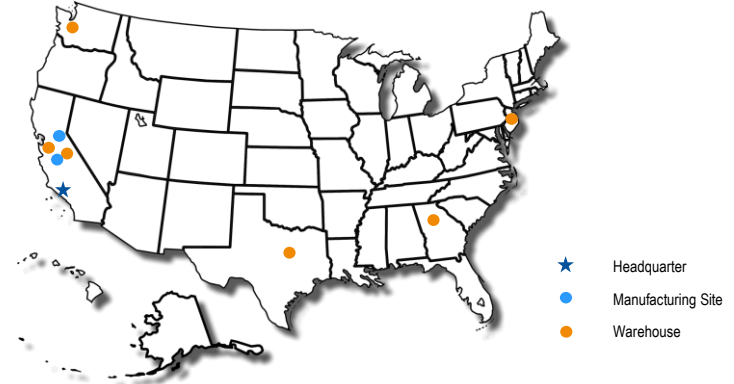

# Balanced Industry Mix with Two Strong Ways to Market\*

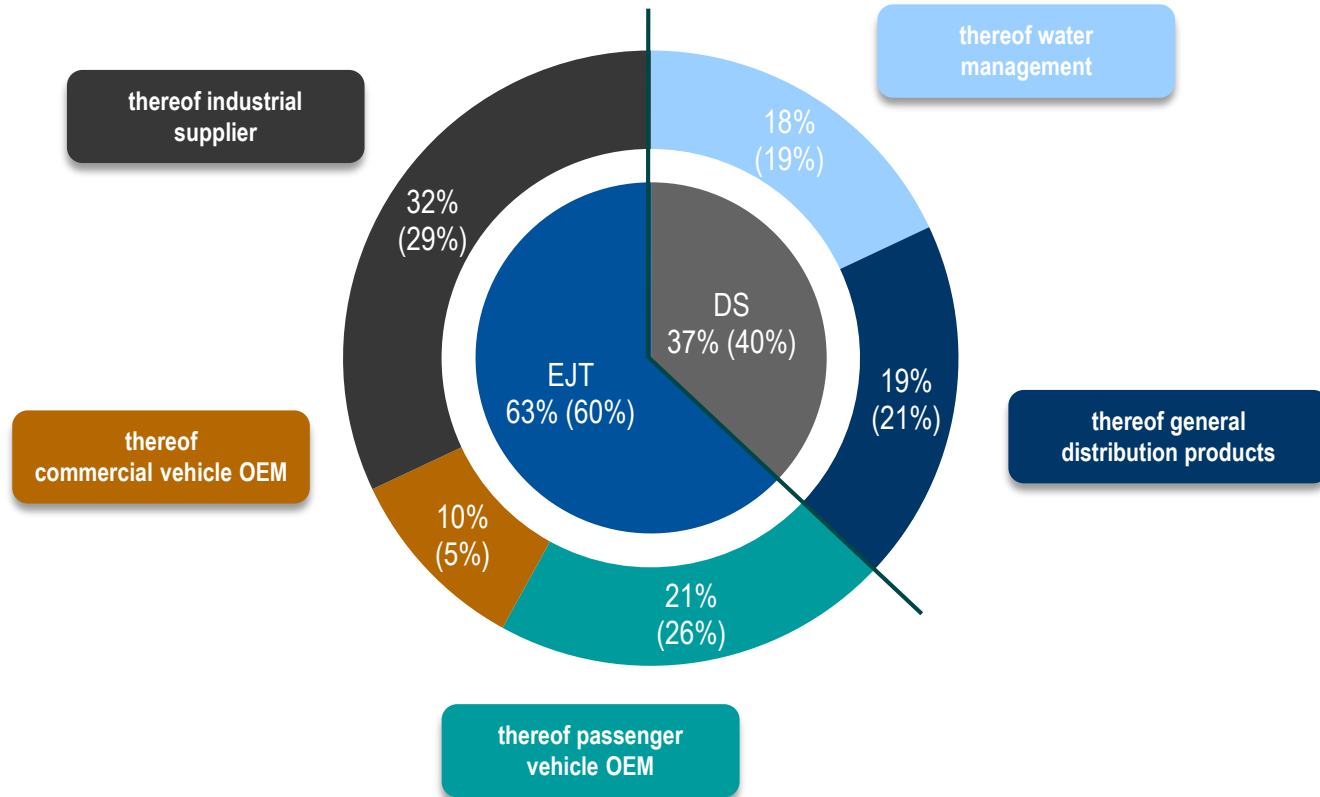

# Historic Growth Track Record



## Historic Revenue Development in EUR million

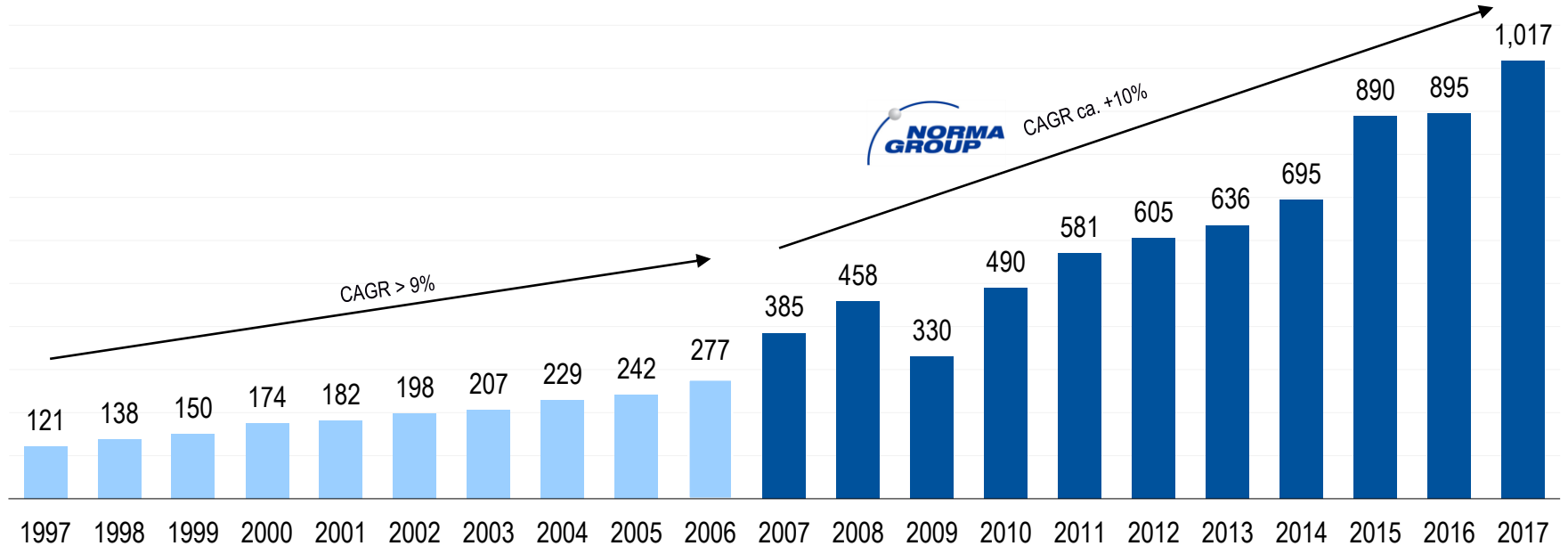

1997 to 2017: 20 years of a successful growth story

# Convincing Growth Prospects

## Clear global market leader in Clamp / Connect

Sales in EUR million (year)\*

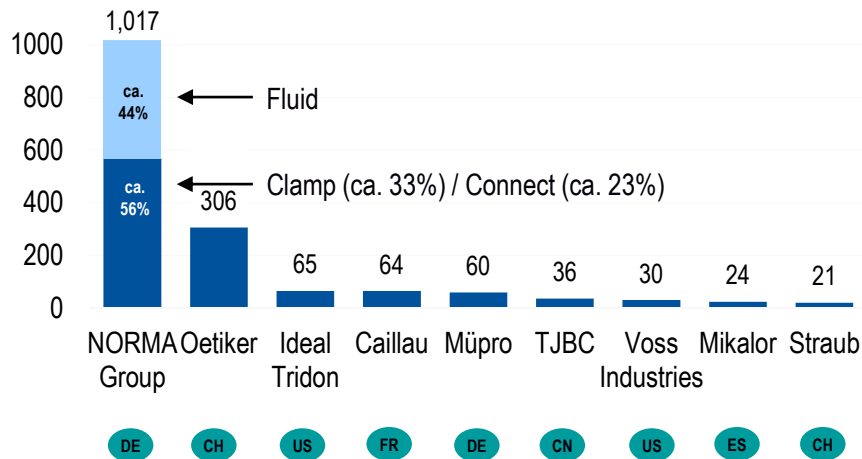

## Excellent growth outlook across EJT market

**Additional growth for Joining Technology market above market growth**

Passenger vehicles	add. 2- 4%
Commercial vehicles	add. 2- 4%
Agricultural equipment	add. 2- 4%
Construction equipment	add. 2- 4%
Engines	add. 2- 4%
White goods	same level
Water management	add. 2- 4%

- NORMA Group expects to grow even faster than its end-markets

# Premium Pricing through Technology and Innovation Leadership in Mission-Critical Components

Mission-criticality: Small relative costs – high impact

## Basis for premium pricing

Market leadership

Technology

Quality

Innovation

Tailor-made solutions

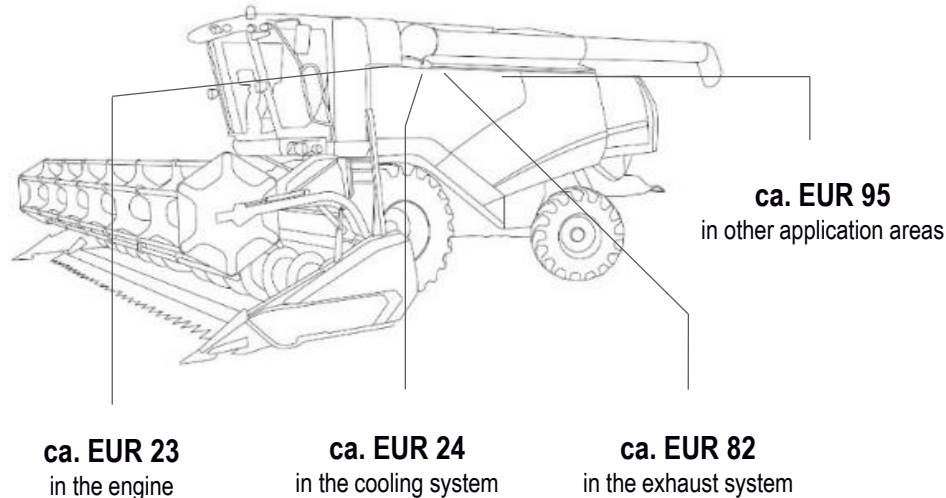

ca. EUR 224  
content per vehicle  
in total

< 0.1%  
content per vehicle

ca. EUR 350,000  
costs an average  
harvester

High switching costs for customers



# Enhanced Stability through Broad Diversification Across Products, End-Markets and Regions



## Examples of NORMA Group's key end markets



- More than 40,000 products, manufactured in 27 locations and sold to more than 10,000 customers in 100 countries
- Top 5 customers account only for around 14% of 2017 sales

# Good Balance in the Two Distinct Ways-to-Market



Distribution Services (DS)  
ca. 37% of 2017 sales

Engineered Joining Technology (EJT)  
ca. 63% of 2017 sales

High quality, branded and standardized joining products provided at competitive prices to broad range of customers



- High quality, standardized joining technology products
- No. 1 product portfolio & service level
- B2C

## Unique business model with two distinct ways-to-market

- Significant economies of scale in production
- Resident engineers with close contact to international EJT customers
  - No. 1 national and international DS service level and DS product portfolio

Innovation and product solution partner for customers, focused on engineering expertise **with high value-add**



- Customized, engineered solutions
- 913 patents and utility models
- B2B

# NORMA Group Provides Mission-Critical Products and Solutions with Clear Added-Value



## A world without NORMA Group



## Customer impact

- Reputation loss
- Image loss
- Warranty costs
- Non-compliance with legal requirements/regulations

Loss of end-customers

## EMEA

Czech Republic (P) - Hustopece  
France (P, D) – Briey, Guichen  
Germany (P, D) – Maintal (3x), Gerbershausen, Marsberg  
Italy (D)  
Netherlands (D)  
Poland (P, D) - Pilica  
Portugal (P) - Águeda  
Russia (P, D) - Togliatti  
Serbia (P) - Subotica  
Spain (D)  
Sweden (P, D) - Anderstorp  
Switzerland (P, D) - Tagelswangen  
Turkey (D)  
United Kingdom (P, D) - Newbury

## Americas

Brazil (P, D) - Atibaia  
Mexico (P, D) – Juarez, Monterrey  
USA (P, D) – Auburn Hills, Saltsburg, St. Clair, Fresno, Lindsay

## Asia-Pacific

Australia (D)  
China (P, D) – Qingdao, Changzhou, Wuxi, Shaoxing City  
India (P, D) – Pune, Nashik  
Indonesia (D)  
Japan (D)  
Malaysia (P, D) - Ipoh  
Singapore (D)  
South Korea (D)  
Thailand (D)



- 30 Production sites
- 23 Countries with Distribution, Sales & Competence Centers
- Sales into more than 100 countries

# NORMA Group – Key Investment Highlights

---



- 1 Market leader in attractive engineering niche markets
- 2 Strong development and growth opportunities in e-mobility and water management
- 3 Enhanced stability through broad diversification across products, end markets and regions
- 4 Engineered products with premium pricing through technology and innovation leadership in mission-critical components
- 5 Strong global distribution network with one-stop-shopping service to specialized dealers, wholesalers and distributors
- 6 Significant growth and value creation opportunity through synergistic acquisitions
- 7 Proven track record of operational excellence

# Highlights 2017 – Strategy

---



## M&A

Successful acquisition of Lifial, Portugal, who has been manufacturing metal clamps for 28 years for use in industry and agriculture

## M&A

Successful acquisition of Fengfan, China, who has been manufacturing joining products made of stainless steel, nylon and specialty materials

## E-Mobility

Increased business volume and development contracts with customers for electric and hybrid passenger cars and trucks

## CR Roadmap

Launch of new CR Roadmap for the period until 2020 with defined targets for the next three years

# Outlook 2018 – Strategy

---

- 1 Continue to develop product and service solutions for **eMobility**
- 2 Expanding water business
- 3 Continue to explore business opportunities particularly in Asia-Pacific to expand regional business and further improve profitability
- 4 Continue dialogue with potential M&A targets in various industries and regions
- 5 Continue proven track record of operational excellence

# Management Board of NORMA Group SE



## Bernd Kleinhens

- Chief Executive Officer (CEO) of NORMA Group SE since January 1, 2018



**Responsibilities:** Business Development, Group Communications, Sales, Product Development, Marketing, Personnel

### Professional background

- 2011 – 2017: Board Member Business Development at NORMA Group SE
- 2014 – 2016: President Asia-Pacific at NORMA Group
- 2010 – 2011: Managing Director of the Business Unit Business Development at NORMA Group GmbH
- 1995 – 2009: Various management positions at NORMA Group and its predecessor companies
- 1997 – 1998: Management position at Rasmussen Group in the US
- 1991 – 1995: Development Engineer at Rasmussen GmbH

### Studies/professional education

- Master's degree in Mechanical Engineering from the Technical University of Central Hessen

## Dr. Michael Schneider

- Member of the Board, CFO of NORMA Group SE since July 1, 2015



**Responsibilities:** Finance, Controlling, Investor Relations, Treasury&Insurances, Legal and M&A, Risk Management, Compliance, Internal Audit, Corporate Responsibility

### Professional background

- 2010 – 2015: Managing Director / CFO, FTE automotive Group
- 2006 – 2009: Member of the Management Board, Veritas AG
- 2003 – 2006: CFO, Aesculap AG (B. Braun Melsungen Group)
- Previous: Various international management positions, thereof 3 years in Brazil

### Studies / professional education

- Master's degree in business economics at the Justus-Liebig-University of Gießen
- PhD in Economics at the Justus-Liebig-University of Gießen

## Dr. Friedrich Klein

- Chief Operating Officer (COO) of NORMA Group SE since October 1, 2018



**Responsibilities:** Production, Purchasing, Supply Chain Management, Operational Global Excellence, Quality, ICT, ESG

### Professional background

- 2008-2018: various leading positions at Schaeffler Technologies AG & Co KG, Herzogenaurach
- 2007-2008: Head of Energy Management at Muhr und Bender KG, Attendorn
- 2005-2007: Director of Operations at Mubea Inc, Florence, USA
- 1996-2004: Various leading positions at Muhr und Bender KG, Attendorn
- 1989-1996: Various leading positions at WZL der RWTH Aachen, Aachen

### Studies / professional education

- Master's degree in Mechanical Engineering from RWTH Aachen
- Doctorate in Engineering from RWTH Aachen





# Appendix

Full Year Results 2017

# Highlights 2017 – Financials (I)



## Sales

Sales of EUR 1,017.1 million (2016: EUR 894.9 million) leads to growth of 13.7%

## Adjusted EBITA

Adjusted EBITA of EUR 174.5 million (2016: EUR 157.5 million)

## Margin

Adjusted EBITA margin at 17.2% (2016: 17.6%); 8th year of sustainable margin higher than 17.0%

## Tax rate

US tax reform leads to a positive one-off non-cash tax effect of EUR 33.9 million in 2017

## EPS

Strong adjusted EPS of EUR 3.29 (2016: EUR 2.96)  
Reported EPS including US tax effect improved by 58.0% to EUR 3.76 (2016: EUR 2.38)

## Highlights 2017 – Financials (II)

### Equity

Strong balance sheet with an equity ratio of 40.7% (2016: 36.2%) despite dividend and acquisition payments including positive US tax effect

### Net Debt\*

Net debt\* decreased to EUR 343.4 million (2016: EUR 392.0 million) including the acquisitions financing and dividend payment

### Leverage

Net debt\* / adj. EBITDA leverage decreased to 1.7x (2016: 2.1x)

### Net Operating Cash Flow

Lower net operating cash flow of EUR 132.9 million (2016: EUR 148.5 million) due to temporarily higher growth related working capital needs

### Dividend

Dividend proposal to the AGM of EUR 1.05 per share – increase of 10.5% compared to previous year 31.9% or EUR 33.5 million of adjusted net income of EUR 105.0 million

### Guidance 2018

Solid organic growth of around 3% to 5%, plus around EUR 5 million from acquisitions  
Sustainable adjusted EBITA margin on the level of the last years of above 17.0%

# Sales by Region

## Regional Split (in % actual vs. (prev. year))

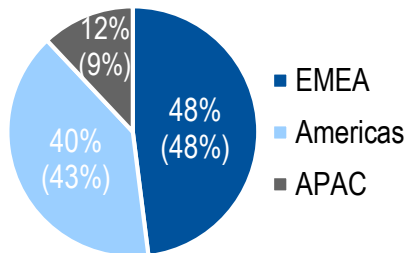

## Sales EMEA (in EUR million)

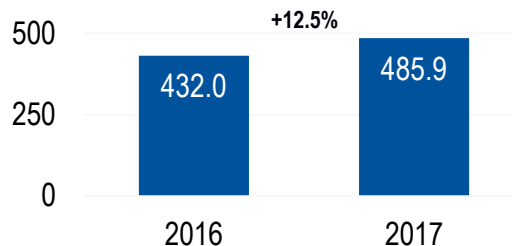

- **EMEA:** Solid growth in EJT includes favorable OEM business while DS sales were also positive – this led in total to a growth of +12.5% including negative currency effects and consolidation of Autoline and Lifal.

## Sales Americas (in EUR million)

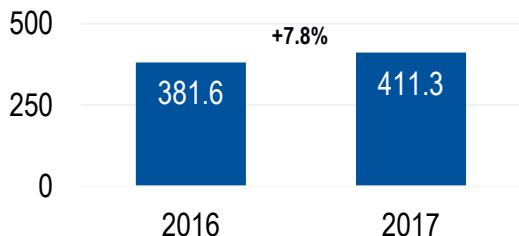

- **Americas:** Strong increase in EJT sales due to recovery of commercial vehicle, agricultural and construction machinery while DS showed a slight growth. Negative currency effects and the consolidation of Autoline led to a growth of +7.8%.

## Sales Asia-Pacific (in EUR million)

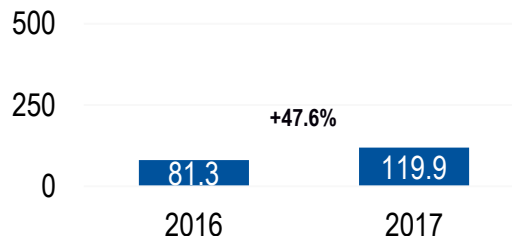

- **Asia-Pacific:** Strong organic growth in the region includes strong growth in EJT as well as in DS. Negative currency effects and the consolidation of Autoline and Fengfan led to a total growth of 47.6% for the region.

# Sales of EUR 1,017.1 million with Solid Organic Growth of 8.6%



- Solid organic growth of 8.6% mainly due to an increase of the global production output of the passenger and commercial vehicle markets as well as new customer and contract wins which led to a high demand for joining products in all regions
- Acquisitive growth of 6.4% from Autoline, Lifial and Fengfan in 2017
- Currency changes in 2017 led to sales decrease of 1.4%

## Sales Development in EUR million

Sales	2016	2017	Change	Change in %	Thereof organic	Thereof acquisitions	Thereof currency
Q1	226.6	254.9	28.3	12.5%	4.6%	6.5%	1.4%
Q2	236.2	264.1	27.9	11.8%	4.9%	5.9%	1.0%
Q3	216.6	244.4	27.8	12.8%	8.6%	7.3%	-3.1%
Q4	215.5	253.6	38.2	17.7%	16.8%	5.9%	-5.0%
<b>FY</b>	<b>894.9</b>	<b>1,017.1</b>	<b>122.2</b>	<b>13.7%</b>	<b>8.6%</b>	<b>6.4%</b>	<b>-1.4%</b>

# Adjusted EBITA of more than 17% for the 8th Consecutive Year

## Adjusted Material Costs (in EUR million and % of sales)

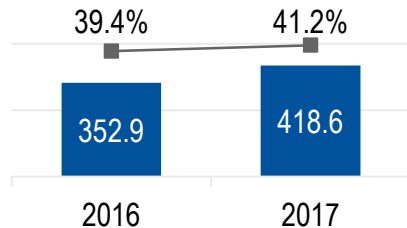

## Adjusted Personnel Expenses (in EUR million and % of sales)

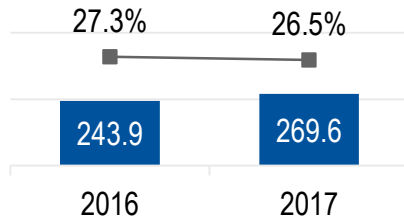

## Adjusted Other OPEX (in EUR million and % of sales)

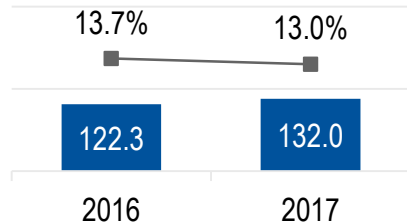

## Adjusted EBITA (in EUR million and % of sales)

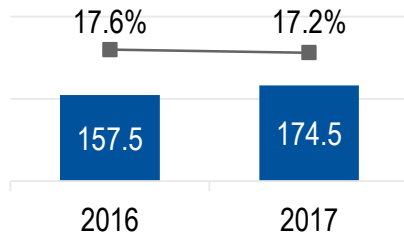

- Material costs ratio up by 180 basis points mainly due to higher alloy surcharges and consolidation of Autoline.
- Personnel expenses higher due to core work force increase but less than sales growth which led to improved personnel cost ratio of 26.5%.
- Improved adjusted other OPEX at 13.0% due to higher business activity.
- Slight decrease of adjusted EBITA margin of 40 basis points to 17.2% mainly due to higher raw material prices.

# Operational Adjustments on EBITA level

- Operational adjustments from the Autoline, Lifial and Fengfan acquisitions in 2017 of EUR 3.5 million

in EUR million	2010	2011	2012	2013	2014	2015	2016	2017
<b>Reported EBITA</b>	<b>64.9</b>	<b>84.7</b>	<b>105.2</b>	<b>112.1</b>	<b>113.3</b>	<b>150.5</b>	<b>150.4</b>	<b>166.8</b>
+ Restructuring costs	1.3	1.8	0	0	0	0	0	0
+ Non-recurring/non-period-related items	15.5*	14.8*	0	0	6.9	3.6	4.8	3.5
+ Other group and normalized items	0.7	0.2	0	0	0	0	0	0
+ PPA depreciation	3.0	1.2	0.2	0.5	1.3	2.2	2.3	4.2
<b>Adjusted EBITA</b>	<b>85.4</b>	<b>102.7</b>	<b>105.4</b>	<b>112.6</b>	<b>121.5</b>	<b>156.3</b>	<b>157.5</b>	<b>174.5</b>

\* mostly IPO related costs

# Operational Adjustments 2017



- Operational adjustments on EBITDA level due to the recent acquisitions
- Higher reported EPS of EUR 3.76 compared to adjusted EPS of EUR 3.29 due to positive one-off non-cash US tax effect of EUR 1.06 per share
- Tax effect overcompensated operational and PPA adjustments and led to a total EPS effect of EUR -0.47

in EUR million	Reported	Adjustments	Adjusted
Sales	1,017.1		1,017.1
EBITDA	196.3	3.5 (incl. EUR 2.9 million integration costs & EUR 1.1 million inventory-step-ups & EUR -0.5 million reimbursement of transaction taxes)	199.7
<i>EBITDA margin</i>	19.3%		19.6%
EBITA	166.8	7.7 (incl. EUR 4.2 million depreciation PPA)	174.5
<i>EBITA margin</i>	16.4%		17.2%
EBIT	137.8	28.2 (incl. EUR 20.5 million amortization PPA)	166.0
<i>EBIT margin</i>	13.5%		16.3%
Net Profit	119.8	-14.8 (incl. EUR -33.9 million US tax effect & EUR -9.1 million post tax impact)	105.0
<i>Net Profit margin</i>	11.8%		10.3%
<b>EPS (in EUR)</b>	<b>3.76</b>	<b>-0.47</b>	<b>3.29</b>

\* Deviations may occur due to commercial rounding.



# Outlook on Adjustments 2018 – 2019



in EUR million	FY 2017	FY 2018*	FY 2019*
EBITDA level	3.5 (incl. EUR 2.9 million integration costs & EUR 1.1 million inventory-step-ups & EUR -0.5 million reimbursement of transaction taxes)	0	0
EBITA level	7.7 (incl. EUR 4.2 million depreciation PPA)	ca. 4 (depreciation PPA)	ca. 3 (depreciation PPA)
EBIT level	28.2 (incl. EUR 20.5 million amortization PPA)	ca. 25 (incl. ca. EUR 21 million amortization PPA)	ca. 22 (incl. ca. EUR 19 million amortization PPA)
Net Profit	-14.8 (incl. EUR -33.9 million US tax effect & EUR -9.1million post tax impact)	ca. 18	ca. 16
EPS (in EUR)	-0.47	ca. 0.57	ca. 0.50

\* depending on foreign exchange rates

# EPS – Dividend Proposal of EUR 1.05 per Share

- Dividend proposal to the shareholders at the AGM on May 17, 2018: EUR 1.05 per share (2017: EUR 0.95)
- Pay-out of EUR 33.5 million for 31,862,400 shares (31.9% of adjusted Group net profit of EUR 105.0 million)
- General policy: dividend of 30% to 35% of adjusted Group net profit

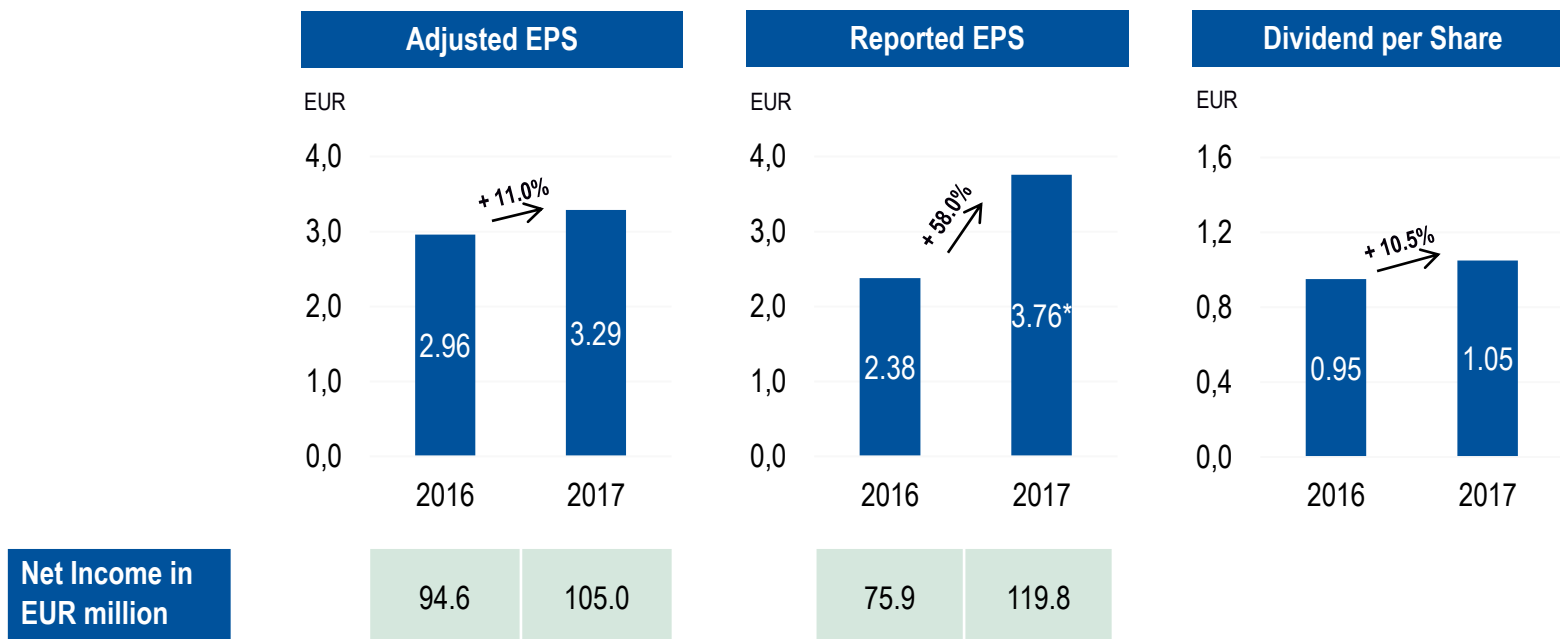

\* including positive one-off non cash US tax effect of EUR 1.06 per share

# Profit & Loss (adjusted & reported)



in EUR million	Adjusted		Reported	
	2016	2017	2016	2017
Sales	894.9	1,017.1	894.9	1,017.1
Gross profit	545.6	601.3	544.9	600.2
EBITDA	179.4	199.7	174.6	196.3
<b>in % of sales</b>	<b>20.0</b>	<b>19.6</b>	<b>19.5</b>	<b>19.3</b>
EBITA	157.5	174.5	150.4	166.8
<b>in % of sales</b>	<b>17.6</b>	<b>17.2</b>	<b>16.8</b>	<b>16.4</b>
EBIT	147.7	166.0	120.0	137.8
<b>in % of sales</b>	<b>16.5</b>	<b>16.3</b>	<b>13.4</b>	<b>13.5</b>
Financial result	-14.6	-16.1	-14.6	-16.1
Profit before tax	133.0	149.9	105.4	121.7
Taxes	-38.5	-44.9	-29.5	-1.9
<b>in % of Profit before tax</b>	<b>28.9</b>	<b>30.0</b>	<b>28.0</b>	<b>1.6</b>
<b>Net profit</b>	<b>94.6</b>	<b>105.0</b>	<b>75.9</b>	<b>119.8</b>

# Working Capital Development

- Trade working capital ratio further improved in 2017 to 15.6% of sales
- In 2017 inventories and trade payables improved, trade receivables increased mainly due to high business activity in Q4 2017 and longer payment terms in strong growing Asia-Pacific region

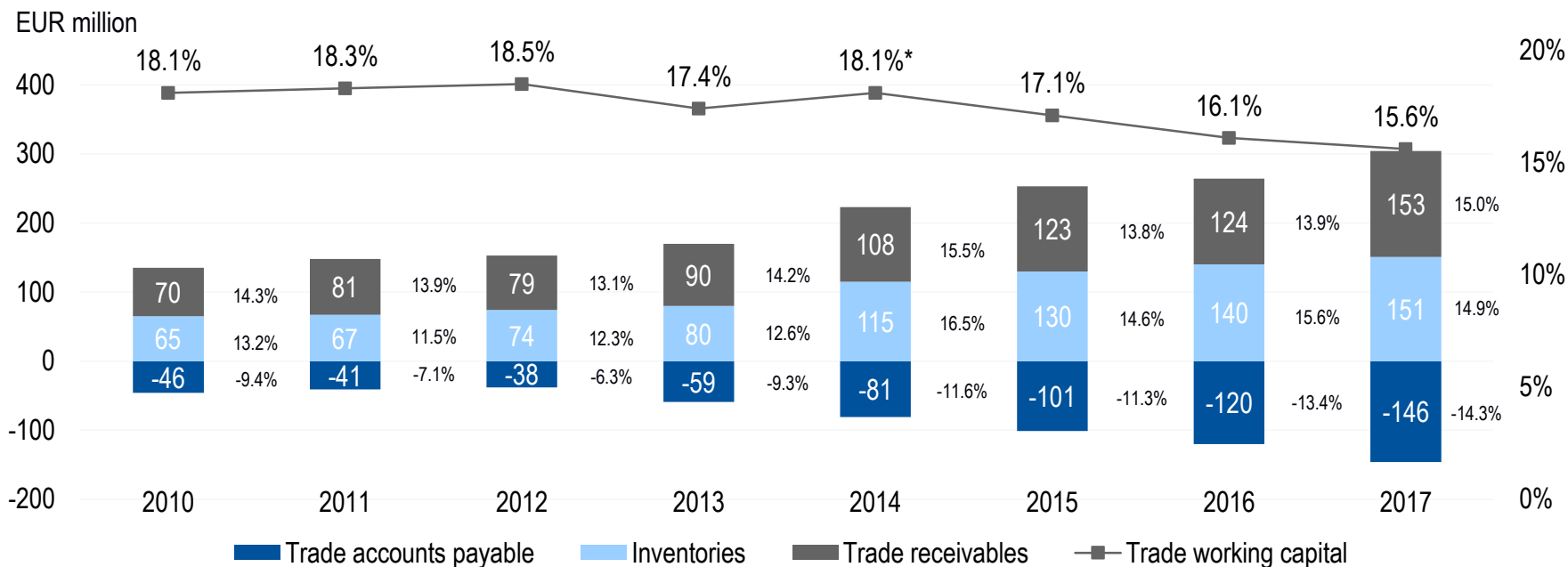

\* 2014: in % of sales run rate of EUR 784 million including NDS sales on full year basis

# Equity Ratio on Strong Level of 40.7%



- Equity increased by EUR 50 million with strong profit of EUR 120 million
- Equity ratio increased despite currency changes and dividend payment due to a strong business activity including positive US tax effect

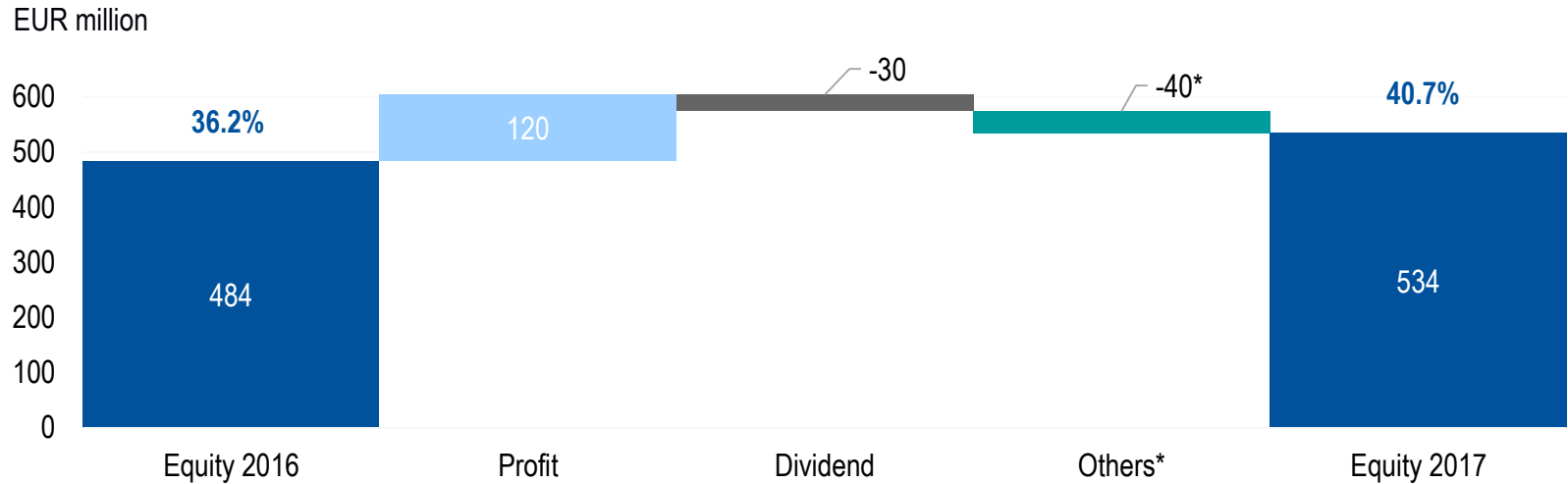

<b>Balance Sheet Total (in EUR million)</b>	<b>1,338</b>
---	--------------

<b>1,312</b>
--------------

\* mainly exchange differences on translation of foreign operations of EUR -36 million

# Net Debt and Financing

## Net Debt\* (in EUR million)

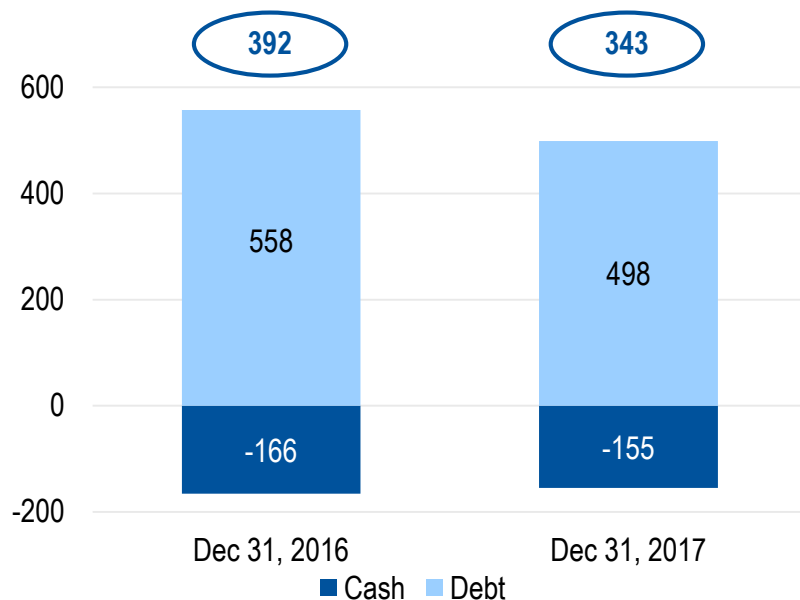

Leverage**	Dec 31, 2016	Dec 31, 2017
(Net debt* / adjusted LTM EBITDA)	2.1 x	1.7 x
Gearing	Dec 31, 2016	Dec 31, 2017
(Net debt* / equity)	0.8 x	0.6 x

\* excl. derivative financial liabilities of EUR 1.4 million (Dec 31, 2016: EUR 2.2 million); Leverage incl. derivatives: 1.7x (Dec 31, 2016: 2.1x); Gearing incl. derivatives: 0.6x (Dec 31, 2016: 0.8x)

\*\* 2017 EBITDA includes full year EBITDA from Fengfan

# Solid Maturity Profile

## Maturity Profile (in EUR million) – Financial Instruments

- Promissory Note 3
- Promissory Note 2
- Promissory Note 1
- Bank Borrowings



## Maturity Profile (in EUR million) – Currencies

- USD
- EUR

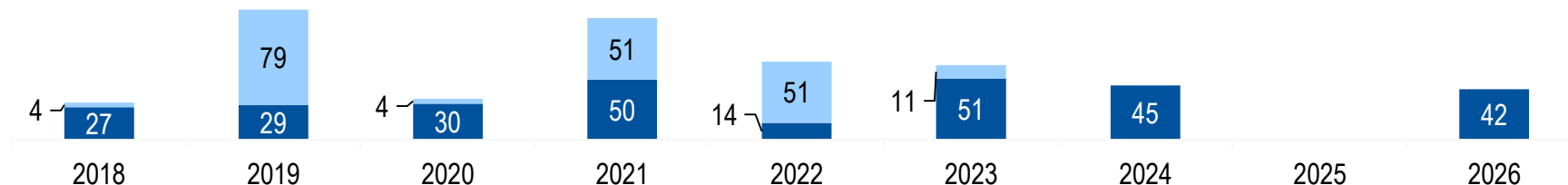

# Solid Development of Balance Sheet



in EUR million	Dec 31, 2016	Dec 31, 2017	in EUR million	Dec 31, 2016	Dec 31, 2017
<b>Assets</b>			<b>Equity and liabilities</b>		
<b>Non-current assets</b>			<b>Equity</b>		
Goodwill / Other intangible assets / Property, plant & equipment	865.5	817.6	Total equity	483.6	534.3
Other non-financial assets / Derivative financial assets /	9.5	7.9	<b>Non-current and current liabilities</b>		
Deferred- and income tax assets			Retirement benefit obligations / Provisions	30.9	30.9
Total non-current assets	875.0	825.5	Borrowings and other financial liabilities	557.6	498.8
<b>Current assets</b>			Other non-financial liabilities	31.8	32.3
Inventories	139.9	151.2	Tax liabilities and derivative financial liabilities	114.2	69.9
Other non-financial / other financial / derivative financial / income tax assets	33.0	27.3	Trade payables	119.6	145.7
Trade and other receivables	124.2	152.7	Total liabilities	854.1	777.7
Cash and cash equivalents	165.6	155.3	<b>Total equity and liabilities</b>	<b>1,337.7</b>	<b>1,312.0</b>
Total current assets	462.7	486.6			
<b>Total assets</b>	<b>1,337.7</b>	<b>1,312.0</b>			



# Solid Net Operating Cash Flow in 2017



## Net Operating Cash Flow

in EUR million	2011	2012	2013	2014	2015	2016	2017	Variance
Adjusted EBITDA	117.0	120.8	129.3	138.4	177.5	179.4	199.7	+11.4%
Δ ± Working capital	-19.5	-9.8	+5.1	+10.4	-0.6	+17.0	-19.1	n/a
<b>Net operating cash flow before investments from operating business</b>	<b>97.5</b>	<b>111.0</b>	<b>134.4</b>	<b>148.8</b>	<b>176.9</b>	<b>196.4</b>	<b>180.6</b>	<b>-8.0%</b>
Δ ± Investments from operating business	-30.7	-30.0	-30.5	-39.6	-42.2	-47.9	-47.7	-0.3%
<b>Net operating cash flow</b>	<b>66.8</b>	<b>81.0</b>	<b>103.9</b>	<b>109.2</b>	<b>134.7</b>	<b>148.5</b>	<b>132.9</b>	<b>-10.5%</b>

- Despite favorable adjusted EBITDA, net operating cash flow before investments decreased by EUR 15.8 million to a total of EUR 180.6 million in 2017 due to outflow of working capital to temporarily support the excellent growth in 2017
- 2017 CAPEX spending at EUR 47.7 million mainly for manufacturing facilities in the US, Mexico, Poland, Serbia, Germany, UK and China
- Net operating cash flow of EUR 132.9 million ensures dividend payment and gives flexibility for further acquisitions

# Continuation of Growth Track and Sustainable Margin in 2017

## Revenue (in EUR million)

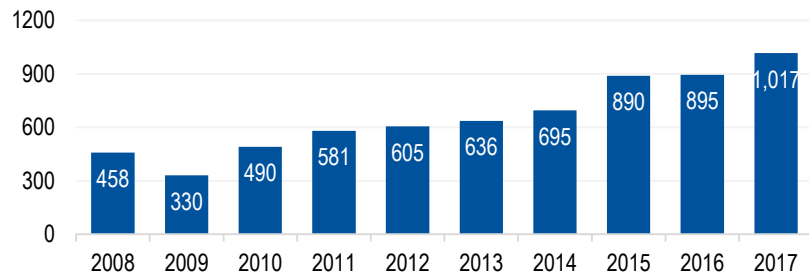

## Gross Profit (in EUR million)

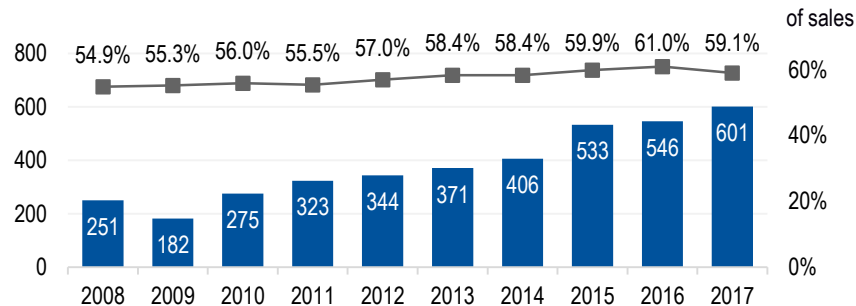

## Personnel Expenses (in EUR million)

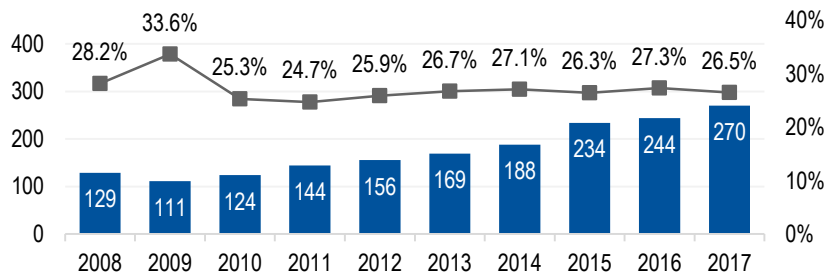

## Adjusted EBITA (in EUR million)

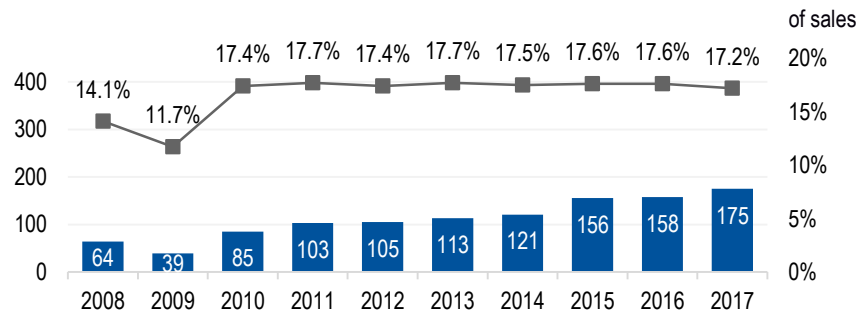

# Pro-active Cash Management Continued in 2017

## Net Operating Cash Flow (in EUR million)

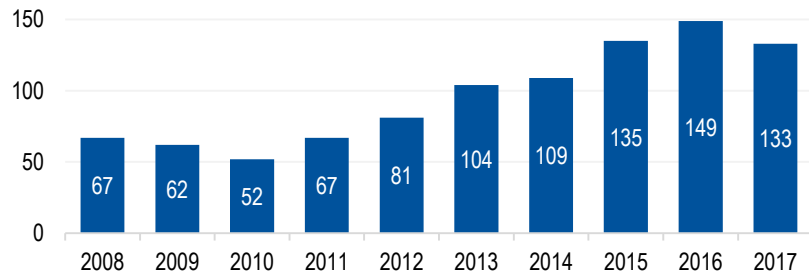

## CAPEX (in EUR million)

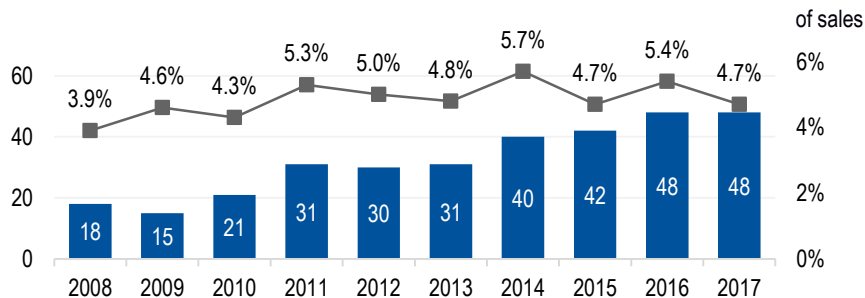

## Trade Working Capital (in EUR million)

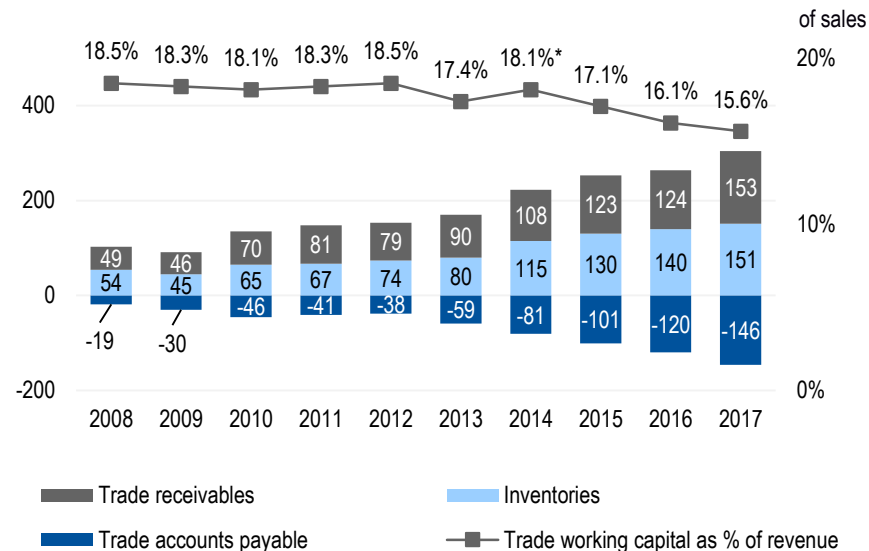

\* 2014: in % of sales run rate of EUR 784 million including NDS sales on full year basis

# Milestones and Current Shareholder Structure



## Milestones and Free Float Changes

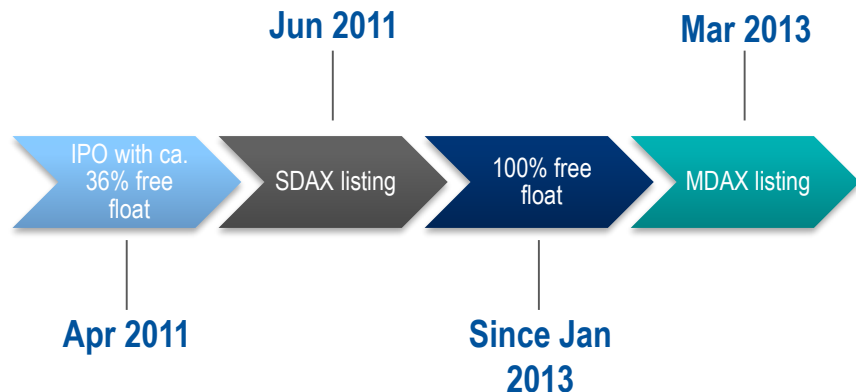

## Identified Institutional Shareholders\*

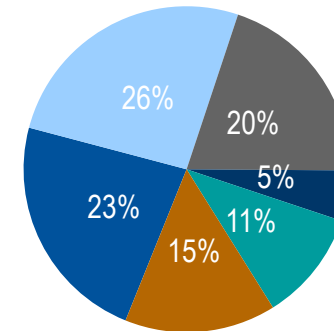

■ Germany ■ United Kingdom ■ USA ■ Nordic ■ France ■ Rest of World

## Free Float includes

Allianz Global Investors GmbH, Germany	10.00%	BNP Paribas Asset Management S.A., France	3.05%
Ameriprise Financial Inc., USA	5.57%	The Capital Group Companies, USA	3.05%
AXA S.A., France	4.98%	Allianz SE	3.04%
Impax Asset Management Group Plc, UK	3.31%	NORMA Group Management*	0.62%

\* as of Sept 30, 2018

# Index-based Share Price Performance compared with MDAX & DAX

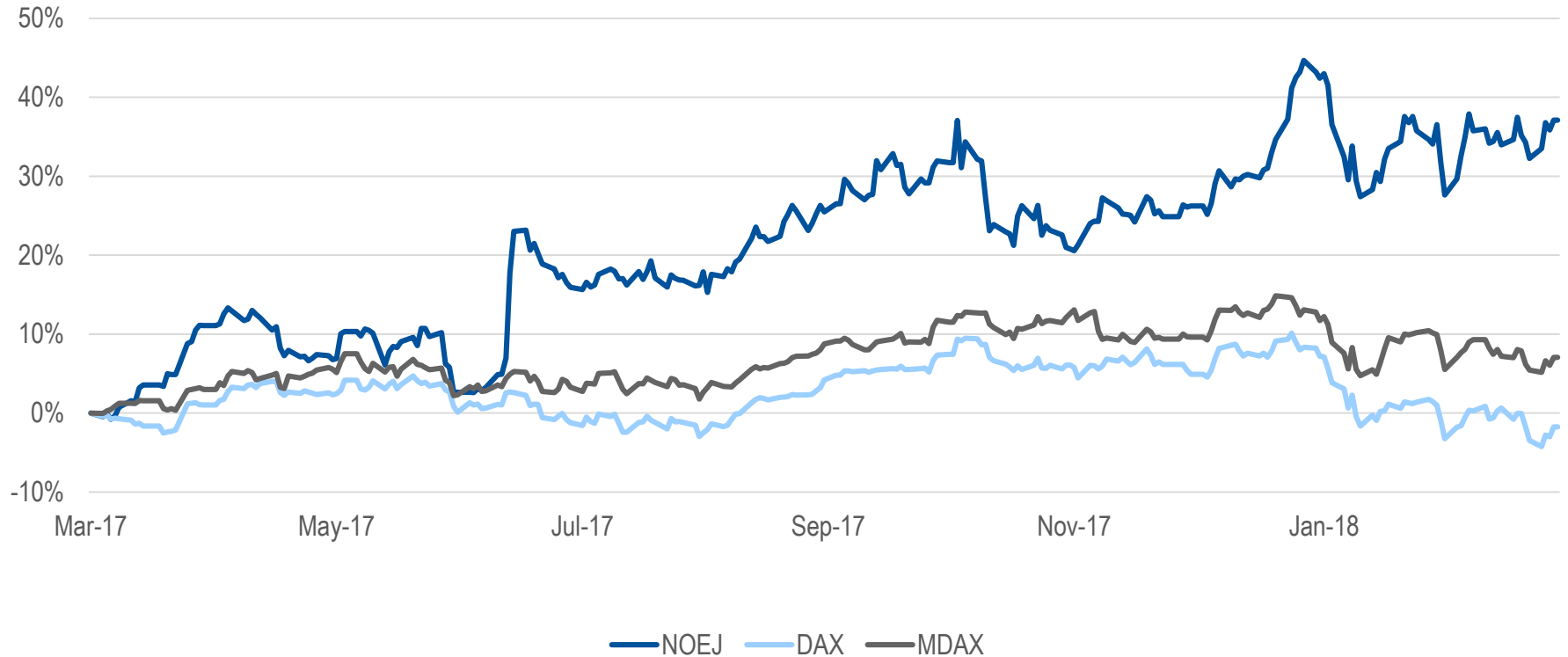

# Contact & Event Calendar



<b>Event</b>	<b>Date</b>
Publication Interim Results FY 2018	February 13, 2019
Publication Annual Financial Report 2018	March 20, 2019
Publication Results Q1 2019	May 8, 2019
Annual General Meeting 2019	May 21, 2019
Publication Results Q2 2019	August 6, 2019
Publication Results Q3 2019	November 6, 2019

## **Contact**

Andreas Troesch

Vice President Investor Relations

Phone: +49 6181 6102-741

Fax: +49 6181 6102-7641

E-mail: [Andreas.Troesch@normagroup.com](mailto:Andreas.Troesch@normagroup.com)

Internet: <https://investors.normagroup.com/>

This presentation contains certain future-oriented statements. Future-oriented statements include all statements which do not relate to historical facts and events and contain future-oriented expressions such as 'believe,' 'estimate,' 'assume,' 'expect,' 'forecast,' 'intend,' 'could' or 'should' or expressions of a similar kind. Such future-oriented statements are subject to risks and uncertainties since they relate to future events and are based on the company's current assumptions, which may not in the future take place or be fulfilled as expected.

The company points out that such future-oriented statements provide no guarantee for the future and that actual events including the financial position and profitability of NORMA Group SE and developments in the economic and regulatory fundamentals may vary substantially (particularly on the down side) from those explicitly or implicitly assumed or described in these statements.

Even if the actual results for NORMA Group SE, including its financial position and profitability and the economic and regulatory fundamentals, are in accordance with such future-oriented statements in this presentation, no guarantee can be given that this will continue to be the case in the future.

Non audited data is based on management information systems and/or publicly available information. Both sources of data are for illustrative purposes only.